 FIMI X8 Pro 2025
User Manual V1.0

Revision Log

Version	Date	Revision Content
V1.0	2025.02	First Edition Release

Table of Contents

Reading Tips	03	Safety Protection	36
Description Of Symbols	03	Auto-return	36
Services & Support	03	Low-power Protection	36
Product Introduction	04	Hovering On The Edge of No-fly-zone	36
Product and Accessories	04	Height And Distance Limitations	37
Function Overview	04	Flight Environment Requirements	37
Drone Component Names	06	Pre-flight Inspection	38
Remote Controller Component Names	07	Novice Mode	38
Prepare	08	Flight	39
Prepare The Drone	08	Basic Flight	39
Prepare The Remote Controller	09	Take Off/Landing	39
Drone	10	Basic Flight Operations	40
Power On/Off The Drone	10	Stop Propellers In An Emergency	40
Flight Mode	10	Automatic Take-off/Landing/Return	41
Downward Vision System	11	Intelligent Flight	43
Flight Mode	12	Follow3.0	43
Drone Light	13	Orbit A Point Flight	44
Intelligent Flight Battery	14	Spiral Flight	45
Intelligent Flight Battery Features	14	Tap-fly	45
Intelligent Flight Battery Usage	15	Waypoint	46
Installation and Removal	18	Precise Landing	46
Propeller	18	Intelligent Flight Mode	46
Installation Intelligent Battery	19	AI Super Night Video	49
Insert Micro SD card	19	Calibration	50
Equip And Remove The Gimbal Protector	19	Compass Calibration	50
Gimbal Camera	20	Gimbal Calibration	50
Working Mode	20	Remote Control Calibration	51
Camera Overview	21	Maintenance	52
Image Storage and Export Methods	21	FIMI Enhanced Video Transmission Module	53
Remote controller	22	Disclaimer	53
Operation And Usage	22	Overview	54
Remote Controller Button Shortcuts	24	Module Installation	55
Remote Controller Indicator Lights	25	SIM Card Installation	55
Remote Control Alerts	26	SIM Card Usage and Selection Instructions	55
Remote Controller Communication Range	26	Enhanced Video Transmission Usage	55
Remote Controller Pairing	27	Precautions	56
FIMI Navi 3.0	28	Specifications	57
Flight Data	28	Basic Specifications	58
Main Page Display	28		
Main Page Function Introduction	29		
Gesture Operations	29		
Image Interface	30		

Reading Tips

■ 1. Description Of Symbols

 · Operation prohibited

 · Important notes

 · Operation, Usage tips

 · Glossary, Reference Information

■ 2. Services & Support

FIMI provides X8 Pro 2025 users with tutorial videos and the following information:

1. 《FIMI X8 Pro 2025 User Manual》
2. 《FIMI X8 Pro 2025 Quick Start Manual》
3. 《FIMI X8 Pro Disclaimer and Safety Operation Instructions》

Users are advised to watch tutorial videos before using the product and read FIMI X8 Pro 2025 Disclaimer and Safety Operation Instructions carefully and get to know the process of using by going through FIMI X8 Pro 2025 Quick Start Manual. For more detailed product information, please refer to FIMI X8 Pro 2025 User Manual. Please download the firmware on the link below : <https://www.fimi.com>

4. Please scan the the following QR-code to download FIMI Navi 3.0



Product Introduction

FIMI X8 Pro 2025 is a foldable and portable quadcopter that integrates advanced technologies such as aerodynamics, 4K 60fps video, expandable interfaces, wireless communication, and an infrared sensing system. It supports long-distance remote control, real-time video transmission, intelligent flight, precise landing, and obstacle detection. The drone is equipped with a compact three-axis mechanical stabilization gimbal camera that ensures stable 4K 60fps video recording and professional image ISP, along with high-definition real-time transmission. The FIMI Navi 3.0 App features a minimalist UI design with larger image display, rich functionality, and fast connectivity. The remote controller is designed with an integrated extendable device holder, supporting up to an iPad Mini, and features detachable joysticks for storage.

1. Product And Accessories

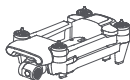

Drone x 1



Battery x 1



Remote controller x 1



Charging case x 1



Charger x 1



Dust plug x 1

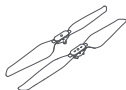

Positive propeller x 3
Reverse propeller x 3

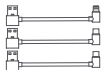

USB cable x 3



Gimbal cover x 1



Instruction x 2



This section displays the standard version of the product; please refer to the actual purchased kit for specifics.

2. Function Overview

· Gimbal Camera Performance

The camera features a Sony 1/2-inch sensor, supporting 4K/60 video recording, AI Super Night Mode, the latest generation AI ISP, and ultra-sensitive noise reduction. The signal-to-noise ratio is improved by 4 times, allowing for clear and vibrant shots even in low light.

· Transmission Distance

FIMI X8 Tele Max uses RokLink 5.0 HD digital transmission technology, offering a maximum communication range of up to 20 km and real-time HD video transmission at 720p 30fps in environments free from interference and obstructions. It supports the latest RokLink 5.0 transmission, utilizing advanced encoding and decoding technology to reduce video transmission latency to as low as 120 milliseconds.

· Smart Flight Functions

The new-generation SoC with powerful computing capabilities can recognize up to 30 different targets, including people, vehicles, boats, and animals, and stably track them. Intelligent flight features such as focus follow, time-lapse photography, waypoint flight, and constant-speed cruise help users effortlessly capture cinematic footage.



- The maximum flight speed of the drone is measured in windless conditions near sea level.
- The longest flight time is measured in windless conditions at a constant speed of 28.8 km/h (8 m/s), with no recording and a 0% battery charge.
- In an open, unobstructed environment with no electromagnetic interference, and with a minimum flight altitude of approximately 119 meters, the remote controller can achieve the maximum communication range (one-way, no return to home) under FCC standards.

■ 3. Drone Component Names

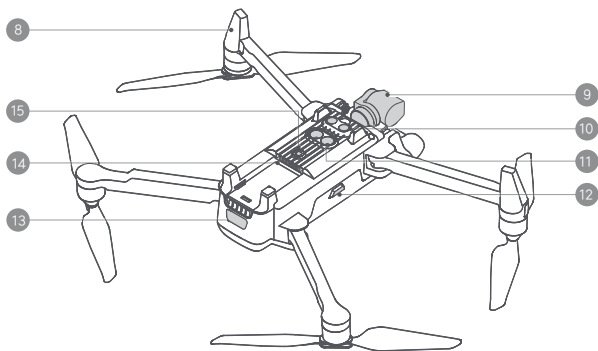
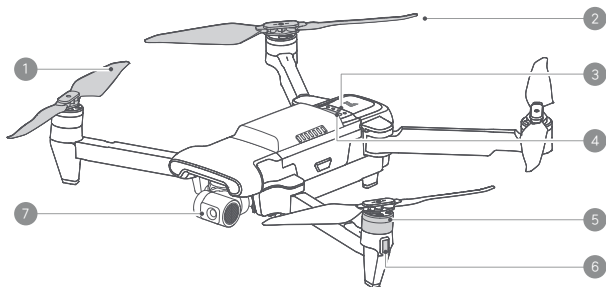

1. Clockwise propeller

2. Counterclockwise propeller

3. Power indicator light

4. Power button

5. Brushless motor

6. Heading indicator light

7. Wide-angle camera

8. Tripod

9. Integrated gimbal camera

10. Infrared sensing system

11. Fill light

12. Battery release button

13. Tail indicator light

14. Module interface

15. Downward vision system

■ 4. Remote Controller Component Names

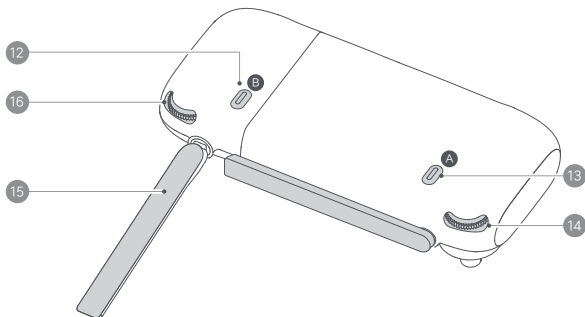
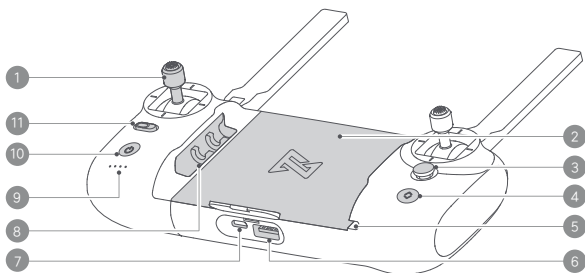

1. Joystick
2. Mobile holder *For securing mobile devices
3. Five-directional button
4. Cancel smart flight/auto takeoff/landing button
5. Cable slot
6. USB port
7. Charging port
8. Stick storage slot *One on each side, used to store the Joysticks
9. Battery level lights *Indicates the remote controller's battery level and other statuses
10. Power button *Press briefly + long press for 2 seconds to power on/off.
11. Auto return *Press and hold for more than two seconds for automatic return; press briefly to cancel
12. Record button *Short press to start/stop recording
13. Shoot button *Press briefly to take a photo
14. Right dial *Slide left or right to adjust EV/ISO
15. Antenna *Dual antennas are foldable
16. Left dial *Moving the levers left and right adjusts the gimbal's pitch angle for shooting

Prepare

The drone is in a folded state when it is shipped. Please follow these steps to unfold the drone.

■ 1. Prepare The Drone

- Remove the gimbal cover

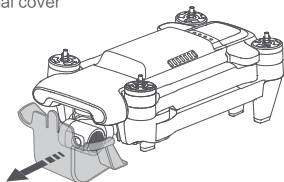

- Unfold the drone. First, unfold the front arms, then unfold the rear arms, and extend all the propellers

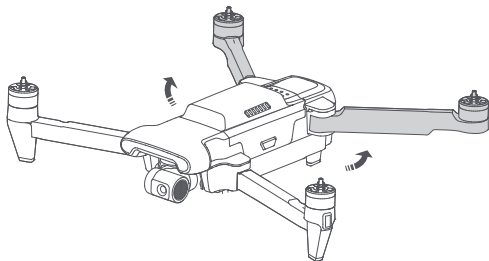
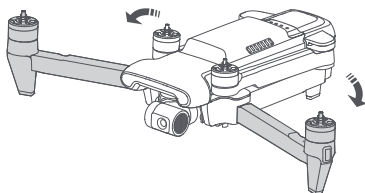

- Before powering on the drone, ensure that the gimbal protector has been removed and that both the front and rear arms are unfolded to avoid affecting the drone's self-check.
- When not using the drone, it is recommended to install the gimbal protector.

■ 2. Prepare The Remote Controller

- Remove the joysticks from the storage slots and screw them into the remote controller in a clockwise direction.

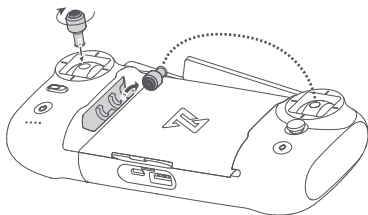

- Extend the antennas

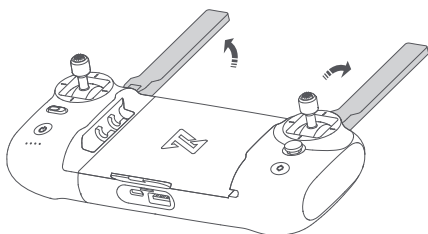

• Remote Controller Device Installation

1. Connect the data cable to the phone interface following the arrow direction.
2. Insert the data cable into the remote controller interface following the arrow direction.
3. Pull the remote controller apart in the direction of the arrows to secure the mobile device.

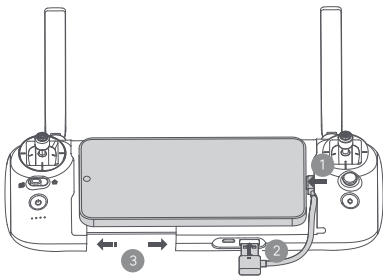

Drone

The drone is mainly composed of the flight control system, communication system, vision system, power system, and intelligent flight battery.

Vocabulary Explanation

IMU	Inertial Measurement Unit (IMU), the most crucial core sensor of the drone
TOF(Time of Flight)	Flight time measurement, which determines the target distance by detecting the time it takes for an infrared signal to travel from the transmitter to the receiver
Downward vision system	Refers to the sensor system composed of the camera and TOF module located on the bottom of the aircraft
Visual positioning	Refers to the high-precision positioning capability achieved through the downward vision system
Compass	Geomagnetic sensor, which helps the drone identify its orientation
Barometer	Barometric pressure sensor, which helps the drone determine its altitude based on atmospheric pressure
GNSS	Global Navigation Satellite System

■ 1. Power On/Off The Drone

- Press briefly + long press for 2 seconds to power on/off.
- Press briefly to check battery level.

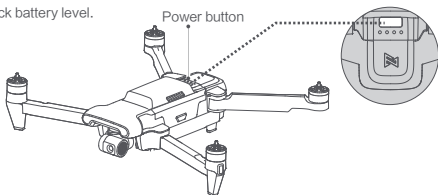

■ 2. Flight Mode

- GPS Mode (Standard)

In GPS Mode (Standard), the drone uses the GPS module for precise hovering and supports intelligent flight features. Users can select either Sport Mode or Beginner Mode in the App. In Beginner Mode, the flight controller restricts flight speed, distance, altitude, and return-to-home altitude. In Sport Mode, the maximum flight speed is 18 m/s, the maximum ascent speed is 5 m/s, and the maximum descent speed is 3.5 m/s.

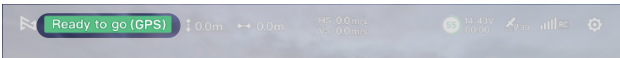

- VPU Mode (Optical Flow)

In VPU (Optical Flow) mode, precise hovering is achieved using the optical flow module, and intelligent flight functions are not supported. The maximum flight speed is 10 m/s, the maximum ascent speed is 3 m/s, and the maximum descent speed is 2 m/s. Switch to VPU mode when flying indoors or when GPS signals are weak and ground textures are clear outdoors.

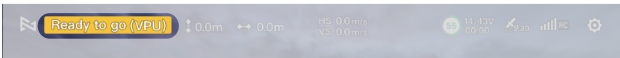

· ATTI Mode (Attitude)

In ATTI (Attitude) mode, when GPS or optical flow signals are weak, the drone will rely on its internal sensors for orientation and altitude control. The maximum flying speed is 18 m/s, with a maximum ascent speed of 5 m/s and a maximum descent speed of 3.5 m/s. In ATTI mode, the drone may drift horizontally and does not support intelligent flight features. To avoid accidents, users should fly in locations with strong GPS signals and open spaces. If the drone enters ATTI mode, land it as soon as possible to a safe location.

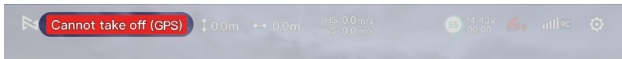

■ 3. Downward Vision System

The product is equipped with a downward-facing sensing system consisting of a monocular camera and a TOF (Time-of-Flight) module. The TOF module includes both an emitter and a receiver, which measure the time taken for infrared signals to travel from emission to reception and reflection, thereby calculating the drone's precise altitude relative to the ground. Combined with the monocular camera, this system enables high-precision low-altitude positioning of the drone.

· Sensing Range

Downward Sensing System: Operates within a height range of 0.3 to 15 meters, with an effective detection range of 0.3 to 5 meters for precise distance measurement. Automatically activates when visual positioning conditions are met.

· Usage Scenarios

The downward vision system's positioning function automatically activates in environments with poor or no GNSS signals. When using visual positioning for flight, the drone will actively limit its flight speed to ensure positioning accuracy and flight safety.

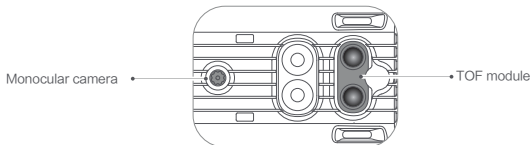

- ⚠ · Users should always be aware of their surroundings and follow relevant warnings from the FIMI Navi 3.0 during flight, maintaining full control of the drone and being responsible for their actions.
- In the absence of GNSS signals, when using the visual system in open and flat areas, the optimal working height range for the visual positioning system is 0.5-15 meters. Flying outside this range may decrease positioning performance, so exercise caution.
- The visual system may not recognize surfaces without texture features and may not function correctly in environments with insufficient or excessive lighting.
- The vision perception system may not work properly in the following scenarios:
 - a. Plain color surfaces (e.g., pure black, pure white, pure green).
 - b. Surfaces with strong reflections or reflections.
 - e. Scenes with rapidly changing lighting conditions.
 - f. Surfaces that are very dark (lighting less than 10 lux) or very bright (lighting greater than 40,000 lux).
 - g. Surfaces with strong infrared absorption or reflection (e.g., mirrors).
 - i. Surfaces with highly repetitive textures (e.g., small checkered tiles of the same color).
- Do not obstruct the downward-facing camera and infrared sensors in any way. If they become dirty, clean them promptly. If damaged, contact after-sales service for repair.

4. Flight Mode

The drone supports the following flight modes, which can be switched using the flight mode¹ shortcut button in the app.



• Cine

The cine mode limits the maximum flight speed, ascent, and descent speeds compared to the cine mode, making the drone more stable during shooting.



• Normal

When you become proficient in flying, you can manually switch to the Standard mode, which is the most commonly used mode. With obstacle avoidance enabled and environmental conditions meeting the visual system's requirements, the maximum flight attitude angle is 30°, and the maximum horizontal flight speed is 16 m/s.

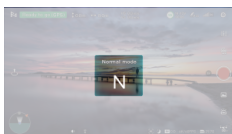

• Sport

In good GNSS conditions, to achieve a stronger flying experience, the maximum horizontal flight speed will be increased to 18 m/s.



- At altitudes above 2400 meters, the Sport mode will be disabled.
- The default factory setting is the Standard mode.



- When using Sport mode, the flight speed of the drone will significantly increase compared to Standard mode, which also results in a much longer braking distance. Please fly cautiously to ensure safety.
- In Sport mode, the drone's attitude control sensitivity will be significantly increased compared to Standard mode, meaning that small movements of the joystick on the remote control will result in more pronounced flight actions.
- In windy conditions, limitations will be lifted to enhance the drone's wind resistance, which may result in gimbal shaking in the footage.
- Videos recorded in Sport mode may exhibit slight shakiness.

■ 5. Drone Light

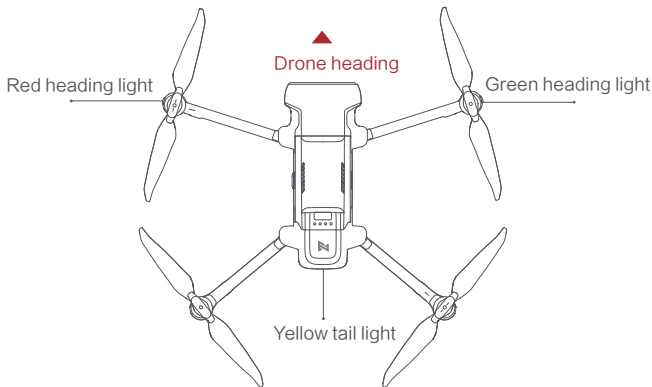

	Indicator light status	Drone status
1	All lights are fading in and out	Self-checking
2	All lights are on	Drone on the ground: self-check fails
		Drone is flying: internal error
3	Red/green heading indicator lights fixed and flashing simultaneously	Ready to fly / in flight
4	All lights flashing twice	Low battery alerts
5	All lights strobe flashing	Battery is critically low during flight, urgent landing required
6	Red and green lights flashing quickly	Firmware upgrading
7	Red and green lights solid on, yellow light flashing	Not connected to the remote controller
8	Fill light	Auxiliary downward infrared system, can be activated automatically/manually

Intelligent Flight Battery

Intelligent flight battery plus (DC04A3) has a capacity of 5000mAh and a rated voltage of 14.4 V. It features charge and discharge management, independent charging, a Type-C charging port, high-energy cells, and an advanced battery management system.

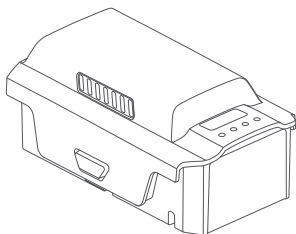

■ 1. Intelligent Flight Battery Features

- **Battery Power Display:** The battery has a built-in power indicator that shows the current battery level.
- **Battery Storage Self-Discharge Protection:** After being fully charged, if left unused for 24 hours, the battery will automatically start discharging to 65% to protect the battery.
- **Balance Protection:** The battery automatically balances the internal cell voltages to protect the battery.
- **Overcharge Protection:** Overcharging can seriously damage the battery. The battery will stop charging automatically once it is fully charged.
- **Charging Temperature Protection:** Charging the battery below 5°C or above 40°C can damage it. The battery will stop charging if the temperature is outside this range.
- **Charging Overcurrent Protection:** Charging with excessive current can seriously damage the battery. The battery will stop charging if the charging current exceeds the limit.
- **Over-Discharge Protection:** Excessive discharge can damage the battery. When the battery is not in use for flight, it will disconnect the output when discharged to a certain voltage. Over-discharge protection will not be triggered during flight.
- **Short Circuit Protection:** The battery will disconnect the output in the event of a short circuit to protect the battery.
- **Cell Damage Detection:** If the battery detects damaged cells or serious imbalance, the app will alert with a message indicating excessive voltage differences or cell damage.
- **Communication:** The drone can obtain real-time battery information, such as voltage, power, and current, through the communication interface on the battery.



It is recommended to fully charge the smart flight battery for the first use.

■ 2. Intelligent Flight Battery Usage

· Check battery level

Press the power button briefly to check the current battery level.

The battery indicator light shows the charging and discharging process of the smart flight battery.

The light indicators are defined as follows:

● LED light is on

● LED light is flashing regularly

○ LED light is off

● LED light is flashing rapidly

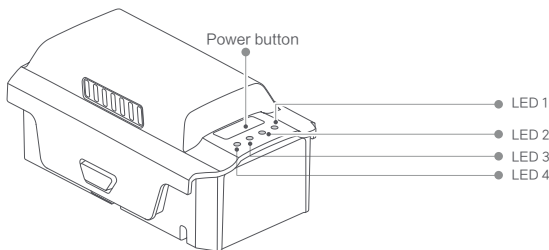

battery level	LED 1	LED 2	LED 3	LED 4
100%	●	●	●	●
75%-99%	●	●	●	●
50%-74%	●	●	●	○
25%-49%	●	●	○	○
0%-24%	●	○	○	○

· Low-Temperature Usage Precautions

- In low-temperature environments (from -5°C to 10°C), ensure that the battery is fully charged. The battery's discharge capability will be reduced in cold conditions. Start the drone to warm up the battery before takeoff (follow the app's prompts).
- The battery cannot be used for flying in environments below -5°C .
- In cold conditions, it is recommended to preheat the battery to above 10°C before flying, with 20°C being ideal.
- In low temperatures, the battery's output power is limited, which can reduce the drone's wind resistance. Operate with caution.
- Extra caution is needed when flying in low-temperature high-altitude environments.

· Charging

Use the FIMI 45W portable charger for charging.

- Connect the portable charger to an AC power source (100-240V, 50/60Hz; use a power adapter if necessary).
- Connect the charger to the charging case. The white indicator light on the charging case indicates that charging is available.
- Connect the charging case to the battery. During charging, the smart flight battery's power indicator light will blink in sequence according to the current battery level. For example, when charged to the third level, the first and second indicator lights will stay on, and the third light will blink. All indicator lights on means the battery is nearly fully charged.
- When all the battery indicator lights turn off, it means the smart flight battery is fully charged. Please disconnect the aircraft and charger to complete the charging process.

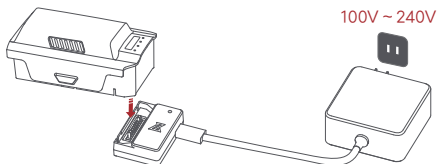

The battery indicator lights during the charging process are as follows:

battery level	LED 1	LED 2	LED 3	LED 4
0%-24%				
25%-49%				
50%-74%				
75%-99%				
Fully charged				

Charging and Discharging Protection Indicator Information:

The battery LED light can display information related to battery protection triggered by charging anomalies as follows:

Protection Features	Display Definitions	LED 1	LED 2	LED 3	LED 4
Overdischarge Protection	LED 1 and 2, LED 3 and 4 Alternately Flashing				
Other Protection Features	Fast Flashing				

Smart Charging Case Indicator Light Explanation:

Flashing Light Patterns	Flashing Light Descriptions
Steady On	Charging Case Power Supply Normal
Flashing	Charging
Off	Charging Complete



· For safety reasons, the smart battery should maintain a low charge (e.g., below 50%) during long-distance or extended transportation.







· The allowable charging temperature range for the battery is 5°C to 40°C. If the temperature is outside this range, the battery will not charge.

- After troubleshooting issues (e.g., excessive charging current, charging short circuit, overcharge leading to high battery voltage, or excessive charger voltage), the battery case indicator light will turn off. After resolving the issue, unplug and reinsert the charger to resume charging. If the charging temperature is abnormal, wait for it to return to normal, and the battery will automatically resume charging without needing to unplug and reinsert the charger.
- After flight, if the smart flight battery is too hot, wait for the battery to cool down to room temperature before charging.
- The allowable charging temperature range for the smart flight battery is 5°C to 40°C. If the temperature is outside this range, the battery management system will prevent charging. The optimal charging temperature range is $25 \pm 3^\circ\text{C}$, which helps extend the battery's lifespan.
- Recharge the battery every 3 months to maintain its activity. Batteries that have not been charged or discharged for over 3 months will not be covered under warranty.
- The smart flight battery must be charged using the official FIMI charger. FIMI is not responsible for any consequences caused by using third-party chargers.
- The charging case's temperature will rise during charging. It is recommended to wait at least 15 minutes after charging before charging the next battery.
- It is recommended to use the FIMI standard PD charger for power supply.
- The charging case is only compatible with FIMI X8 series batteries. Do not use the charging case to charge batteries of other models.
- Place the charging case on a stable surface and ensure insulation and fire prevention.
- Do not touch the metal terminals with your hands or any other objects.
- If there is foreign matter on the metal terminals, wipe them clean with a dry cloth.

Installation and Removal

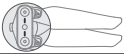
1. Propeller

The propellers on the drone motors are designated as clockwise (CW) and counterclockwise (CCW). The two propellers on the same motor are identical, with marked and unmarked propellers indicating different rotational directions. Be sure to follow the instructions strictly, installing the different propellers in their corresponding positions.

	propellers	Installation Instructions	Installation Diagram
Marked		Install marked propellers on the marked arms	
Unmarked		Install unmarked propeller on the unmarked arms	

• Installation propellers

- Extend the front and rear arms of the drone.
- Align the propellers with the corresponding colored markings on the arms.
- Ensure the propeller is pressed onto the motor shaft until it reaches the base, then rotate the propeller to secure it. Once released, the propeller will snap into place and lock.
- To remove the propeller, press it down firmly and rotate to detach.

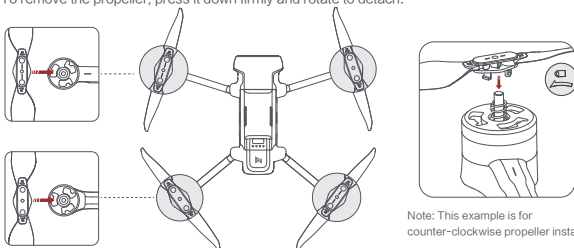

Note: This example is for counter-clockwise propeller installation.

- ⊘ Do not get close to the rotating propellers and motors to avoid injury.
- Do not block the motor ventilation slots.
- Stay away from the propellers during flight to prevent injury.
- Never insert a screwdriver or any sharp objects into the motor ventilation holes, as this may severely damage the motor.
- Do not block the motor ventilation holes or the ventilation holes on the aircraft's body.
- Do not modify the motor's physical structure on your own.

- 💡 Use only FIMI-provided propellers; do not mix propellers of different models.
- Before each flight, check if the propellers are installed correctly and securely fastened.
- If the propellers are damaged, replace them with new ones to ensure flight safety and efficiency.
- Before each flight, ensure the motors are securely installed, free of foreign objects, and able to rotate freely.
- After the motor stops rotating, do not touch the motor immediately with your hands to avoid burns.
- Ensure the ESC (Electronic Speed Controller) emits a sound after the aircraft power is turned on.
- Propellers are consumable items, so purchase replacements if needed.
- If you experience flight instability, reduced speed, or shorter flight time, check the condition of the propellers. Replace them if damaged or deformed.
- Ensure there are no foreign objects inside the motor, that it can rotate freely, and that there are no unusual sounds. If the motor makes any strange noises, replace it promptly.

■ 2. Installation Intelligent Battery

- Hardly push the battery, after the battery installed in place, there will be a "click" sound.
- To remove the battery, you need to press the bottom buckle to pull out the battery.

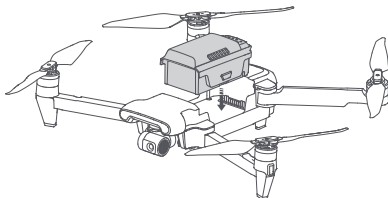

Installing the Battery

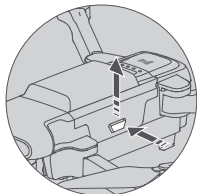

Removing the Battery

 Please ensure the battery is properly installed, as improper installation could pose a flight safety risk.

■ 3. Insert Micro SD card

- When installing the aircraft SD card, extend the right front arm of the aircraft and open the interface protection cover.
- Insert the SD card with the labeled side facing up into the aircraft's card slot.
- To remove the SD card, simply press down on the card, and it will pop out.

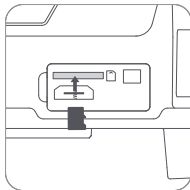
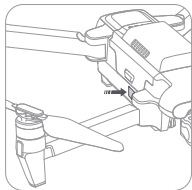

■ 4. Equip And Remove The Gimbal Protector

- Equip and remove the gimbal protector as shown

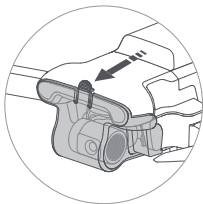

Equip the gimbal protector as the arrow leading

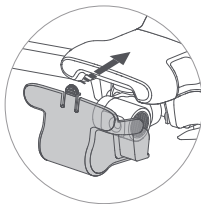

Remove the gimbal protector as the arrow leading

 Before powering on the product, make sure to remove the protector.

Gimbal Camera

FIMI X8 Tele Max gimbal is an integrated unit featuring three-axis mechanical stabilization technology with an angular vibration range of $\pm 0.005^\circ$. It provides a stable shooting platform for the camera, ensuring smooth and steady footage even during high-speed flight.

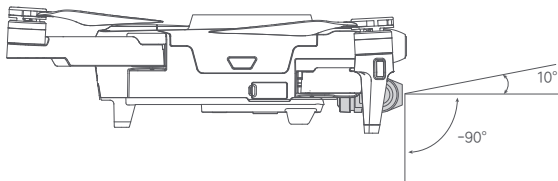

■ 1. Working Mode

The gimbal can operate in Follow Mode and FPV Mode to suit different shooting needs. FPV mode can be selected in the FIMI Navi 3.0 interface by navigating to Image Transmission -> Intelligent Flight -> Flight Mode -> Fixed-Wing.

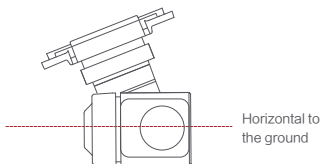

Follow:

The angle between the gimbal's orientation and aircraft front remains constant at all times.

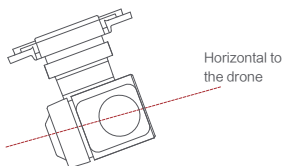

FPV:

The gimbal synchronizes with the movement of the aircraft to provide a first-person flying experience.

- ⚠ Before takeoff, ensure there are no objects on the gimbal and place the drone on a flat, open surface. Avoid touching the gimbal after the power is turned on.
- The gimbal contains precision components. If it is bumped or damaged, these components may be harmed, which could lead to decreased gimbal performance. Handle the camera gimbal carefully to avoid physical damage.
- Keep the gimbal clean and avoid contact with sand, stones, or other foreign objects, as these could obstruct the gimbal's movement and affect its performance.
- Do not apply force to the gimbal after powering on.
- Do not attach any objects to the camera gimbal, as this could affect its performance or even damage the motor.
- Remove the gimbal protector before turning on the device. Reinstall the gimbal protector during storage or transportation to protect the gimbal.

■ 2. Camera Overview

X8 Pro 2025 camera has been upgraded with a 1/1.3-inch CMOS 48MP image sensor, featuring dual native ISO and support for direct HDR image output. The wider dynamic range enhances the richness and depth of the visuals.

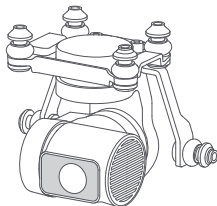

- ⚠️ AI Super Night Mode automatically detects the surrounding lighting conditions through the image sensor and prompts whether to activate or manually enable the mode.
- Do not expose the camera lens to environments with laser beams (e.g., laser shows) to prevent damage to the camera sensor.
- Use and store the camera within the specified temperature and humidity range to maintain optimal lens performance.
- To clean dirt or dust from the lens surface, use professional lens cleaning tools to avoid affecting the image quality.

■ 3. Image Storage and Export Methods

· Storage

The X8 series is equipped with a MicroSD card slot for expanded storage. To capture high-quality videos and photos, the storage device must support fast write speeds. Please use a UHS-I Speed Grade 3 or higher MicroSD card to ensure optimal shooting performance. For recommended cards, please refer to the storage card list in the FIMI official website specifications. Photos and videos cannot be captured if the MicroSD card is not inserted.

· Export

After removing the microSD card from the drone, insert it into a card reader to export the image data. Alternatively, you can download the original photos and video files from the media library in the app.

· Micro SD Card Specifications

- File Format: FAT32, exFAT
- Capacity: 8GB to 512GB
- Speed Requirement: It is recommended to use an SD card with a U3 (UHS Speed Class 3) rating or higher

- 💡 The video files downloaded from the media library may have different resolutions compared to the original transmission video. For higher-quality videos, please use a computer or other devices to read the MicroSD card.

- ⚠️ Using some U1/C10 Micro SD cards may result in a slow card warning due to their low write speed.
- Do not insert or remove the MicroSD card during recording. Doing so may damage the card and result in data loss.
- Before using the device for important recordings, conduct several test shoots to ensure the equipment is functioning correctly.
- Make sure to properly shut down the smart flight battery; otherwise, camera settings may not be saved and recorded videos may be corrupted. FIMI is not responsible for any losses due to unreadable videos or photos.

Remote controller

Remote controller, paired with the X8 Pro 2025, uses RokLink 5.0 transmission and supports real-time transmission of 720p/30fps HD video. It allows operation and settings of the aircraft and camera within a maximum range of 20 km in an unobstructed, interference-free environment. The controller features removable joysticks and has a 3900 mAh battery, providing a maximum operating time of approximately 4.5 hours.

■ 1. Operation And Usage

- Power On/Off
- Short press + Long press the power button for 2 seconds to turn the remote controller on or off.
- Short press the power button to check the battery level.

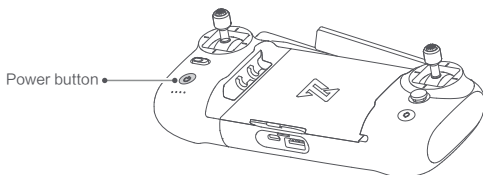

- Controller Functions

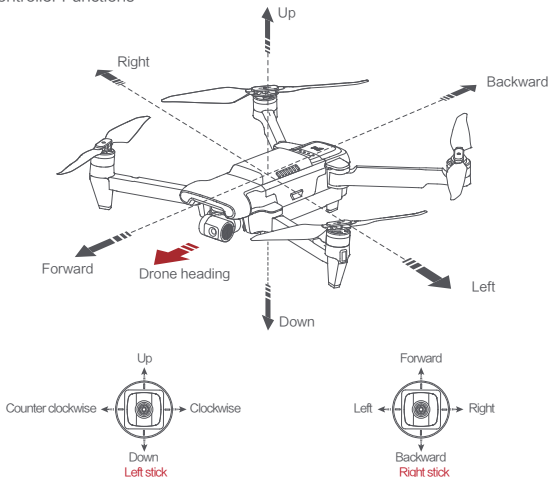

The settings for the remote control sticks can be adjusted in the remote control settings menu (default is for American hands).

	Buttons	Function description	
1	Left stick	Push stick upward, the drone goes up; pull stick downward, the drone goes down; toggle stick to left, the drone rotates counter-clockwise; toggle stick to right, the drone rotates clockwise	
2	Right stick	Push stick upward, the drone flies forward; pull stick downward, the drone flies backward; toggle stick to left, the drone flies to left; toggle stick to right, the drone flies to right	
3	Auto return	Toggle the button to the left, switching to normal flight Toggle the button to the right, switching to auto return	
4	Auto take-off/land button	long press 2 seconds to auto take off/landing	
5	Shoot button	short press to start / stop shooting	
6	Record button	Short press to start /stop recording	
7	Five directional button	Up	Default to switch between map / FPV
		Down	Default to switch between gimbal center/down
		Left	Default to turn on / off battery info interface
		Right	Default to turn on / off self-checking interface
		Center	Default to turn on/off media library
8	Left dial	Adjust the pitch angle of gimbal	
9	Right dial	Adjust the value of EV / ISO	
10	Power button	Short press to view the battery level Short press+long press 2 seconds to power on / off	



- The other functions of the five-directional button can be set in the FIMI Navi 3.0 App.
- The joystick function is the default mode, which can be set through the FIMI Navi 3.0 App.

Sticks Control

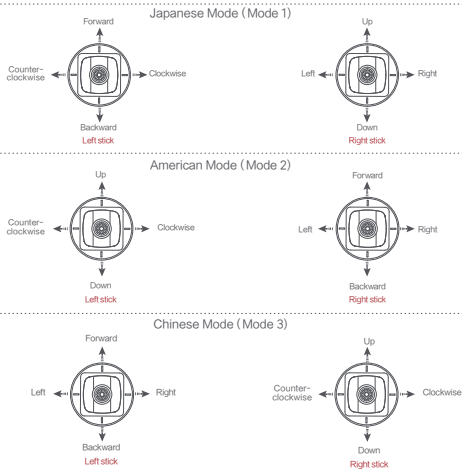

2. Remote Controller Button Shortcuts

- Press the photo button once, and after hearing two short beeps, the camera will take a photo.
- Press the record button once to start recording; press it again to stop recording after hearing four short beeps.
- Use the left scroll wheel to adjust the gimbal's pitch angle by turning it up or down.
- Use the right scroll wheel to adjust the camera's EV/ISO settings.
- After holding down the record button, use the right scroll wheel to adjust the camera's zoom by turning it up or down.

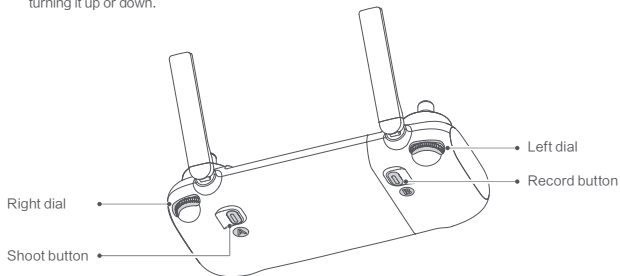

3. Remote Controller Indicator Lights

As shown in the diagram, the remote controller is equipped with four white LED lights that indicate battery level and other statuses.

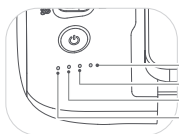

· Light status of remote controller

Remote lights status	Remote status
Power button's red light are on	Weak signal
Power button's red light flashes	Not connected to the drone
Power button's red light flashes	RC Pairing or upgrading firmware
Power button's white light is on	Normal signal
Power button's white light flashes	Recording videos
Auto take-off/landing button's red light is on	Auto take-off or landing not enabled
Auto take-off/landing button's white light on	Allow Auto Takeoff or Auto Landing

· Remote Controller Battery Level Display

LED1	LED2	LED3	LED4	Battery level
●	●	●	●	75% < Battery level ≤ 100%
●	●	●	○	50% < Battery level ≤ 74%
●	●	○	○	25% < Battery level ≤ 49%
●	○	○	○	10% < Battery level ≤ 24%
●	○	○	○	The remote controller beeps to warn that the battery level is less than 10%.

· Charging

- As shown in the image, connect the charging cable to the remote controller's charging port.
- While charging, the battery indicator light will flash.
- Once charging is complete, the battery indicator light will turn off.
- In the powered-off state, it takes approximately 2.5 hours to fully charge.

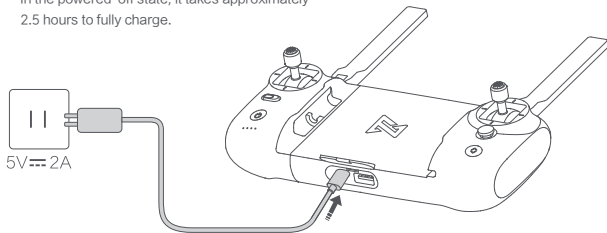

· Remote controller charging indicator status

LED1	LED2	LED3	LED4	Current Battery Level
				0%-24%
				25%-49%
				50%-74%
				75%-99%
				99%-100%

■ 4. Remote Control Alerts

In certain scenarios or when the remote control encounters an error, it will emit continuous "beep" alerts. For specific details, refer to the real-time prompts in the FIMI Navi 3.0.

The return-to-home alert sound cannot be disabled. The low battery alert at less than 10% cannot be disabled, and when the battery level drops below 3%, the urgent alert sound cannot be disabled.

■ 5. Remote Controller Communication Range

- When operating the drone, it's important to promptly adjust the orientation and distance between the remote controller and the drone, as well as adjust the antenna position to ensure the drone remains within optimal communication range.
- When the antenna forms a 180° or 270° angle with the back of the remote controller, and the antenna plane is directly facing the drone, it can optimize the signal quality between the remote controller and the drone.

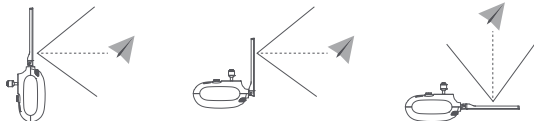

- Do not use other communication devices on the same frequency band simultaneously, as it may interfere with the remote controller's signal.
- In actual operation, FIMI Navi 3.0 will provide a notification if the video transmission signal is poor. Follow the prompts to adjust the antenna position and ensure the drone is within the optimal communication range.

6. Remote Controller Pairing

The remote controller and the drone are paired at the factory and can be used directly after powering on. When replacing with new equipment, re-pairing is required to use. The steps are as follows:

- Power on the drone.
- Power on the remote controller, then wait for 20 seconds. After that, press and hold the power button until the remote controller emits a beep, and the red light on the power button starts flashing.
- Press the pairing button on the drone briefly. The yellow light on the drone's tail will turn off.
- Once pairing is successful, the white light on the remote controller's power button will stay on, and the yellow light on the drone will remain on.
- After pairing is successful, the indicator light on the remote controller will change from flashing sequentially to a steady light, and the tail light of the drone will turn on.

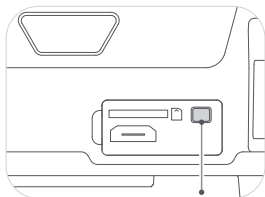

Drone Pairing Button

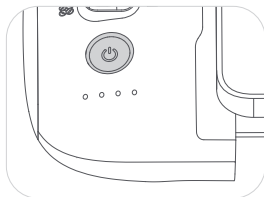

- Please ensure the drone and the RC stay within 0.5m while pairing.
- Ensure the battery level of drone and RC are more than 30%.

FIMI Navi 3.0

- FIMI Navi 3.0 interface and specific functions may vary slightly with app version updates. Please refer to the actual version used for the specific interface and functions.

1. Flight Data

- The FIMI Navi 3.0 has a flight data recording feature that allows users to view their flight data within the app.
- Flight records can capture basic data for each flight.
- Flight logs will record detailed flight data.
- If users encounter issues during a flight, they can provide feedback within the app, and if necessary, upload flight logs to receive assistance.
- After downloading the app, the first use will direct you to the login page.

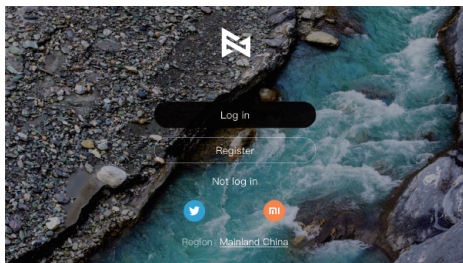

- Using the FIMI Navi 3.0 without logging in will restrict access to some features, such as flight data recording, dynamic no-fly zone requests, and FIMI's flexible exchange service.
- For a complete service experience, logging in is recommended.
- All flight data is stored on the user's mobile device, and the company will not access any of your flight data unless you actively upload it to the cloud.

2. Main Page Display

Swipe left or right to select the desired drone model. If the remote controller is connected, it will automatically switch to the corresponding model.

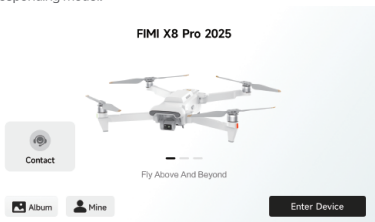

3. Main Page Function Introduction



Click "Mine" to Enter Settings Page

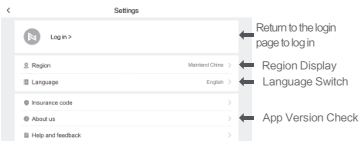

Return to the login page to log in

Region Display Language Switch

App Version Check



Swipe left or right to switch between aircraft models. If the remote controller is already connected to the aircraft, the app will automatically recognize and switch to the corresponding model.

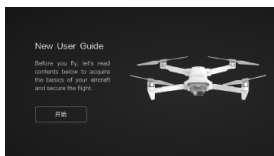

Tap to enter the device.

On the first use, you will be directed to the beginner's guide page.

4. Gesture Operations

Enter the live view interface, swipe left to enter full-screen mode, and swipe right to exit full-screen mode.

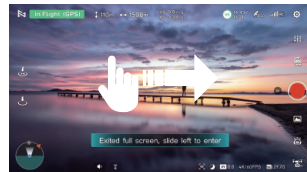
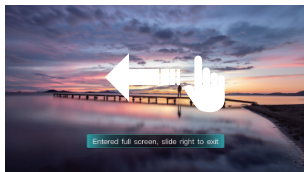

■ 5. Image Interface

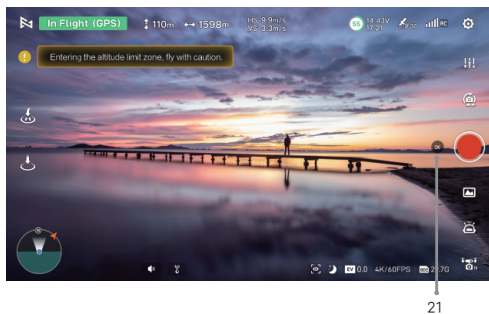





1. Return To Login Interface

Z: Tap to return to the login interface.

2. The Current Flight Mode Of The Drone

In Flight (GPS): Flight mode display: green bar: GNSS mode, yellow bar: VPU mode, red bar: ATTI mode.

3. Real-time Parameter

-  : Height from the home point.
-  : Distance from the home point.
-  : Vertical speed of drone.
-  : Horizontal speed of drone.



4. Intelligent Flight Battery Power

-  : Display the real-time battery percentage, battery voltage, and flight time countdown. Click to view more battery information.

5. GNSS Signal Strength

-  : Display the GNSS signal strength, low signal strength, marked in red; medium signal strength, marked in red; high signal strength, marked in white, click to enter the drone settings page. When the icon is white, it means the GNSS signal is good and you can refresh the return point.

6. Mapping Signal Quality

-  : Displays the current image transmission signal strength between the aircraft and the remote controller.
-  : Displays the 4G network and mobile device signal strength.

7. System Settings

-  : Including drone parameter settings, camera parameter settings, remote control parameters, gimbal settings, battery information, other parameter settings and so on.

: Drone

Flight speed, distance, altitude, return altitude setting:

- Turn Beginner Mode on/off (limits speed, distance, altitude). The drone will be restricted to a cylindrical space with a radius of 100m and altitude of 50m, and will operate in Normal mode.
- Set the drone's loss of signal handling (Return-to-Home/landing/hover).
- FPV display of the HOME point, turn Precise Landing on/off, turn indicator lights on/off, check magnetic field interference, calibrate the compass, set Return-to-Home point, adjust control feel, toggle night vision assistance light mode, and configure GNSS settings.
- Reset drone parameters: Restore all settings to factory defaults.
- GNSS configuration allows for the selection of different satellite systems.

: Remote controller

- Remote Controller Calibration: Calibrate the joystick center, sensitivity, and maximum range of the roll wheel.
- Joystick Modes: Japanese Mode, American Mode, and Chinese Mode
- Five-way Button Customization: Set individual functions for Up, Down, Left, Right, and Center.

: Gimbal

- Gimbal calibration, gimbal pitch speed, advanced settings.
- Gimbal pitch speed, adjustable gimbal pitch speed.
- Advanced settings, gimbal gain, fine-tuning function.
- Reset gimbal parameters, restore factory default settings.



: Video Transmission

- Video transmission frequency band, displays the frequency range in use.
- Channel mode, can select manual/automatic.
- Signal interference, displays the current signal interference intensity.



: Intelligent Battery Information

- View the smart battery's individual cell voltage, current power, cycle count, temperature, over-discharge count, and other information.



: Other

- View flight records, unit settings, sensor data, firmware version, and find aircraft information.

8. Camera parameter settings



: Click to expand the relevant options.



: Video mode selection: Normal video, time-lapse video, super night mode.

Video resolution: Choose the resolution and frame rate.

Video quality: Select from Low, Medium, High; default is Medium.

Other settings: HDR, white balance, exposure mode, color, portrait mode, video encoding format.



: Image parameter settings

Mode selection: Manual/Automatic, with corresponding parameter settings.



: Camera settings

Select to turn the grid lines on/off, histogram on/off, SD card status display, hardware decoding on/off, format the SD card, and reset camera parameters.

9. Switch the current camera mod



: Quick switch, allows for fast switching between photo and video modes.

10. Shooting Buttons



: Tap to start recording video.



: Tap to start shooting photos.

11. Media Library



: Enter to download and view the videos and photos stored on the aircraft's camera Micro SD card.

12. Smart Flight



: Click to enter the Smart Functions page. Intelligent Flight includes Pointing Flight, Route Flight,

Follow 3.0, Point Wrap Flight, Spiral Flight.

Flight modes include Aerial Mode, Tripod, Heading Lock, Fixed Wing, SAR.



: Waypoint flight.



: Flight paths are flown.



: Follow.



: Point wrap flight.



: Spiral flight.





: Aerial mode.



: Tripod mode.



: Flight direction locked.

-  : Fixed wing.
-  : SAR mode.





13. Drone gear mode

-  : Display the current aircraft gear mode, click to switch between “Sport” “Normal” “Cine” mode
 - Sport: Max horizontal speed 18m/s, Max ascent speed 5m/s, Max descent speed 4m/s.
 - Normal: Max horizontal speed 10m/s, Max ascent speed 4m/s, Max descent speed 3m/s.
 - Cine: Max horizontal speed 6m/s, Max ascent speed 1.5m/s, Max descent speed 1.5m/s.

14. SD Card Status Bar

-  : Displays the remaining capacity and total capacity of the SD card, with a quick access option to SD card settings when clicked.

15. Camera current mode parameter display

-  : The current video resolution/frame rate is displayed in the video mode and the image size is displayed in the photo mode, and you can set the video or photo mode, resolution, image size, white balance, style and so on by clicking on it.
-  : Displays the current Shutter value. In manual mode, click to set.
-  : Displays the current ISO value, in manual mode, click to set.
-  : The current EV value is displayed, click to set.

16. AI Super Night View

-  : AI Super Night View shortcut switch in video mode.

17. Follow 3.0









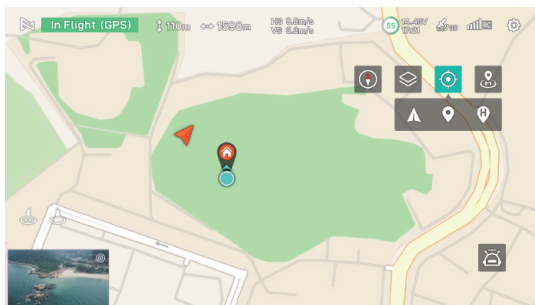



-  : Click into the Follow 3.0 mode.

18. Zoom Map / Attitude Sphere

-  : Real-time display of the vehicle position, click to switch the mapping interface/attitude sphere/thumbnail map/full-screen map display.





Interface of map

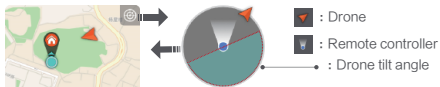



-  : Tap to toggle to have the aircraft position centered or the aircraft and phone positions co-centered.
-  : Display the location of the drone.
-  : Display the location of the Home.
-  : Display the location of the phone.
-  : Tap to correct the direction.
-  : Switch the map.
-  : Home point.
-  : Tap to switch to guided map.
-  : Represent the direction of the phone.
-  : The position of drone to the phone. And the direction of the drone.
-  : Compass.
-  : The position and percentage of the blue area on the circle represents the current attitude of the vehicle in the horizontal and pitch directions.



The Attitude Sphere displays information about the drone's nose orientation, tilt angle, remote control orientation, and return point location. The attitude ball is able to reflect the drone's angle and direction in real time, as shown in the following figure. The attitude ball can reflect the angle and direction of the drone in a realistic way, as shown in the figure below:

Attitude Ball Legend				
Drone tilt direction	Forward tilt: the water level line is biased toward the upper half of the stance sphere	Backward tilt: the water level line is biased toward the lower half of the stance sphere	Tilted to the right: the water level line is tilted to the right	Tilted to the left: the water level line is tilted to the left

19. Shortcuts

-  : Tap to auto takeoff.
-  : Tap to auto land the drone.
-  : Tap to return the drone.

20. Information Status Bar

-  : Displays alerts for no-fly zones, environmental changes, temperature, sensor calibration, and other notifications.

21. Visible Light Camera Zoom

-  : Click to adjust the zoom of the visible light camera.

- ⚠ · Do not point the thermal imaging camera lens at strong energy sources, such as the sun, lava, laser beams, etc., while using the camera. Doing so may burn the camera sensor and cause irreversible damage.
- Super Night View is based on the main camera image sensor to read the surrounding environment sensitivity whether to open, such as objects blocking the lens for more than 5s will have the probability of false alerts.
- Please make sure your mobile device is fully charged before flying.
- If you need to use cellular mobile data when using the App, please contact the data provider of your mobile device to get the latest data traffic rate information.
- When using the app, please make sure to read and understand the pop-up messages and warnings, and always know the current status of the drone.
- If your mobile device is too old, it may affect the experience of using the App, so it is recommended to change your mobile device.
- Drone altitude limits and restricted areas vary from country to country, so please comply with local laws and regulations.

Safety Protection

1. Auto-return

The drone is equipped with an automatic return function, the return trigger is mainly divided into user-initiated trigger, the drone low-battery trigger, lost connection trigger (remote control and the aircraft between the loss of communication signals).

Support lost return to home only in GPS mode. When the GPS signal is good, the compass works normally and the drone has successfully recorded the takeoff point, if the drone loses connection with the remote control signal for more than 2s, it will be judged that the drone has lost connection. The flight control system will take over the control of the drone and plan the return route with reference to the original flight path, and the drone will fly back to the take-off point. If the signal connection between the drone and the remote control returns to normal during the return process, short press the return button  to take the lost connection and return, the vehicle will be returned to the control right.

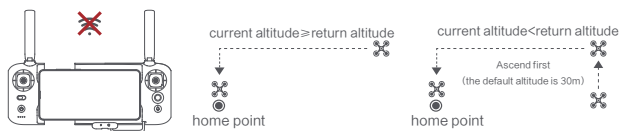

2. Low-power Protection

During flight, when the battery level is only sufficient for return, the app will prompt the user to return.

When the battery level reaches 30% (default), the app will prompt a low battery warning and suggest landing as soon as possible. When the battery level drops to 10%, the aircraft will begin to automatically land. During the landing process, clicking the button on the right side of the remote controller  or using the app can stop the automatic landing to adapt to different environments.

 · Low battery alarm range can be set in the App.

3. Hovering On The Edge of No-fly-zone

The drone will automatically hover in the restricted flight area designated by the state, such as the edge of airports, and the App will appear corresponding hints. The user can use sticks to fly the drone from the edge of the no-fly-zone, but the drone will not enter the no-fly-zone.



■ 4. Height And Distance Limitations

Maximum altitude is used to limit the altitude of the vehicle and maximum distance is used to limit the distance of the vehicle, which can be set by the user in the FIMI Navi 3.0.

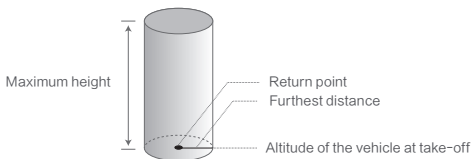

GNSS Good Signal

	Flight restriction	FIMI Navi 3.0
Maximum height	The flight altitude will not be able to exceed the maximum altitude set in the FIMI Navi 3.0	Indicates that the maximum altitude has been reached.
Furthest distance	The straight-line distance of the vehicle from the return point will not exceed the maximum distance set in the FIMI Navi 3.0	Indicates that the maximum distance limit has been reached

■ 5. Flight Environment Requirements

- The drone is dangerous and not suitable for use and operation by persons under 16 years of age and other persons who do not have full capacity for civil behavior.
- Please ensure that you keep a certain distance from people, animals, trees, vehicles and buildings during the use of the airplane. Please maneuver carefully when people are approaching.
- Please keep away from dangerous environments such as airports, railroads, highways, high-rise buildings and utility poles when operating the drone.
- Please stay away from areas with complex electromagnetic signals such as communication base stations and high-power antennas when operating the drone.
- The flight altitude and flight distance of the aircraft relative to the take-off point will be limited according to relevant regulations and policies.
- Do not use this product at locations and times where the use of such products is prohibited by regulations and policies.
- In order to protect the legitimate rights and interests of users, please ensure that the product safety instructions are observed during use.
- Please do not fly in bad weather such as windy, rainy, snowy and foggy.
- Please choose a location with good GPS signal and open environment to fly.
- It is recommended that the user is guided by an experienced user for the first flight.
- It is recommended to fly in the environment with good visibility, please pay attention to the safety of flight at night operation.
- This product is integrated folding design, does not support the installation of protective devices.
- This product does not support the use of overweight does not have the ability to load, more than the maximum takeoff weight of the drone may bring the uncontrollable flight, the resulting loss is borne by the user, and has nothing to do with FIMI.
- All flight data are saved in the user's mobile device, except for the user's initiative to upload to the cloud, the company will not get any of your flight data.

■ 6. Pre-flight Inspection

- Make sure that the battery power of the drone and the remote control are sufficiently charged.
- Make sure that the propeller is properly installed and that the propeller is not damaged or deteriorated.
- Make sure that the gimbal protector has been removed and the camera lens has been cleaned.
- Confirm that the SD card has been inserted.
- Confirm that gimbal protectors have been removed.
- Front and rear arms are fully deployed in place.
- The camera and gimbal are working properly when the power is turned on.
- FIMI Navi 3.0 is connected and working properly.

■ 7. Novice Mode

Defaults to Novice Mode the first time you use the drone.

In Novice mode:

- Flying distance and altitude will be limited to: 0–100m.
- Speed gear is limited to photography gear.
- It is recommended for beginners to learn and skill the flyer in novice mode first.

Flight

1. Basic Flight

- Confirm the direction of the drone
- The gimbal camera position is the nose direction.
- Direction can also be determined by the color of the status light on the tail of the drone when the drone is turned on.

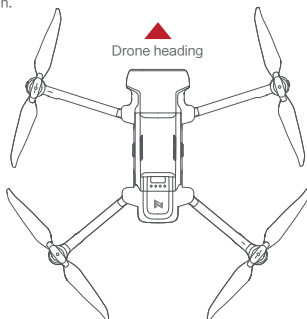

-  · Safety tip: Keep the tail facing the operator when maneuvering the craft to avoid misjudging the direction.

2. Take Off/Landing

- Keep both sticks to the bottom inner still over 3 seconds, the propellers start spinning.
- Release both sticks once propellers spinning, and firmly push the left stick upward to take off the drone.
- When the drone in flight, release the sticks and the drone will hover automatically.



- Slowly move the left stick downward to land the drone.
- Once the drone landed, pushed and hold the left stick down over 5 seconds, the motors will stop.

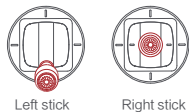

-  · When taking off, be sure to place the drone on a smooth and fixed plane, does not support hand-held and palm takeoff or landing.
- The drone is not waterproof, do not land on water, and for safety reasons, do not land on an inclined surface.

3. Basic Flight Operations

- Toggle the two rockers of the remote control inward and downward to the maximum extent, in the shape of an inner eight and hold it for more than 3 seconds, the paddles start to rotate.
- After the paddles start to rotate, release the two joysticks back to the center at the same time, and push the left joystick upward to take off the aircraft.
- During the flight, release the two joysticks of the remote control, the flying machine will hover automatically.

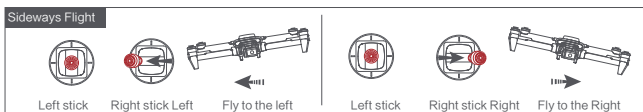
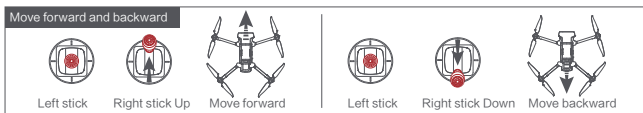
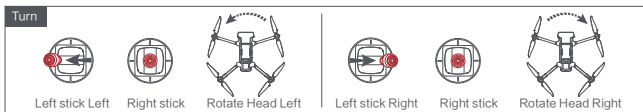
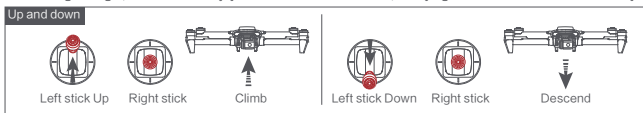

⚠ Remote control joystick settings can be changed in the remote control setup menu (default is US hand)

4. Stop Propellers In An Emergency

- When motors can't properly turn off, please toggle the left stick to the bottom inner in maximum range, and press Auto return-to-home button for 5 seconds simultaneously, the motors will stop.

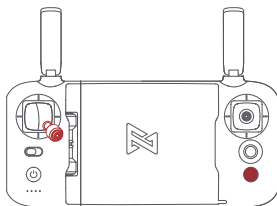

⚠ Do not do the operation above during normal flight to avoid motors being stopped in the air.

■ 5. Automatic Take-off/Landing/Return

· Automatic takeoff

When the drone meets the automatic takeoff conditions, click the automatic takeoff button on the left side of the APP "🚀" Follow the instructions, the drone will automatically take off, and when it reaches the specified altitude the APP prompts that the automatic takeoff is complete.

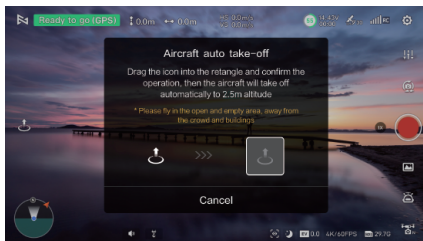

In GPS mode, the drone automatically takes off and hovers at 2.5 meters from the ground waiting for the joystick command; in VPU mode, the drone automatically takes off and hovers at 1.2 meters from the ground waiting for the joystick command.

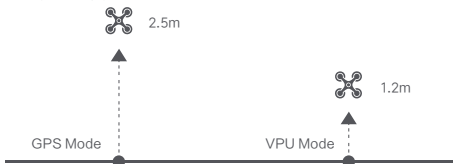

· Automatic landing

When the drone meets the conditions of automatic landing, click the automatic landing button on the left side of the APP "📵" Follow the instructions to operate, the drone will be in the current flight position vertically descending to the ground, and when it reaches the ground the propeller stops rotating the APP prompts that the automatic landing is complete.

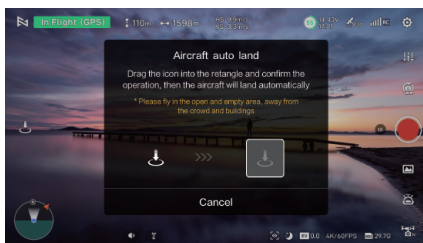

· Automatic return

When the drone is in the air, the user can long press the return button on the remote control with the remote control beep. Or through the auto return button on the left interface of the APP "🏠" to let the drone into the automatic return, after reaching the ground, the APP prompts that the automatic return has been completed.



When the drone is flying in the air, the user can long press the return button on the remote control to let the drone enter the automatic return. When the drone return distance $D < 10$ meters, if the flight altitude $H < 3$ meters, the drone rises to 3 meters and then return to the take-off point to land; if the flight altitude $H \geq 3$ meters, the drone directly maintains the current altitude to return to the take-off point to land. When the drone return distance $D \geq 10$ meters, if the flight altitude $H < 30$ meters, the drone first rises to 30 meters and then returns to the takeoff point to land; if the flight altitude $H \geq 30$ meters, the drone directly maintains the current altitude to return to the takeoff point to land. Users can cancel the automatic return flight through the remote control return button or through APP.

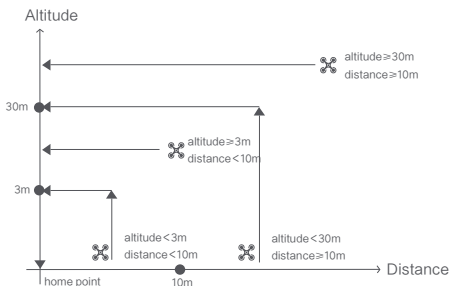

Intelligent Flight

1. Follow3.0

Follow-flight is supported only in GNSS mode.

Users can enter the Smart Flight menu from the "📶" icon in the Fimi Navi 3.0 APP, click "Follow Flight" to select Normal Follow, Parallel Follow or Locked Follow, and the drone will follow the target selected in the APP as the tracking target.

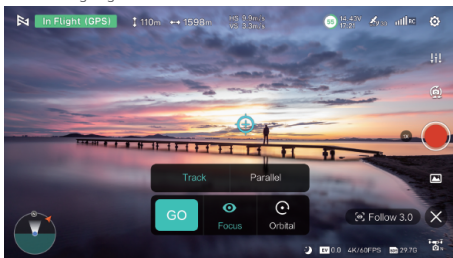

· Ordinary following

In normal following mode, the nose of the drone is always aimed at the tracking target, and flies at a certain distance with the tracking target moving direction as the course.



· Parallel following

In parallel following mode, the nose of the vehicle is always aligned with the tracking target and flies at a certain distance with the fuselage left and right directions as the course.

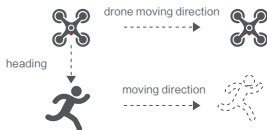

· Target Lock

In Lock mode, the flight speed is 0, and the aircraft hovers to lock onto the target.

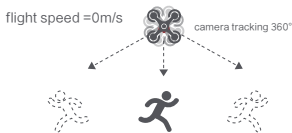

· Target Orbit

The drone will orbit 360 degrees around the target position. Users can adjust the flight speed, and the drone will maintain a certain distance from the target while flying around it.

flight speed = 0m/s

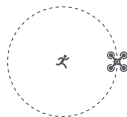

- ⚠ During the following flight, the user should make sure that the following path always avoids people, animals and obstacles, etc. to ensure the flight safety.
- Users must comply with local laws and regulations when using the follow-flight function.

■ 2. Orbit A Point Flight

The user selects orbit a point flight on app, set the center point and radius. The drone will fly around the centerpoint at a default speed. If the user sets a POI, the drone will lock and shoot the POI. Fly away from the central point to set radius. Set flight speed, move direction and heading. If the heading is free, the user can drag a rectangle around a POI.

- Fly to a point first to set the center point.
- Then set the flight radius by starting with the center point.
- Set the flight speed, movement direction and heading.
- After setting the parameters, click "GO" to execute.

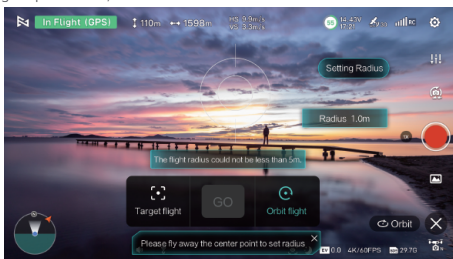

During the orbit a point flight, you can set the steering and speed of the go-around flight on the Fimi Navi 3.0 APP, and click "X" to exit the orbit a point flight.

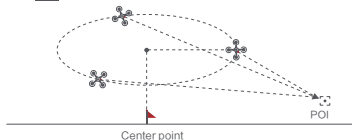

If sticks are moved in flight, the flight altitude or radius will be changed. Taking Mode 2 as an example:



3. Spiral Flight

Users can select the spiral mode in the app, set the center point and radius, and the craft will hover up and shoot video at the same time, showing a strong sense of space.

- Fly to a point set to the center point.
- Fly away from the center point set to radius.
- Set the circling direction and flight distance while starting the video recording.
- Operate the joystick during flight and the craft will interrupt the spiral airplane.

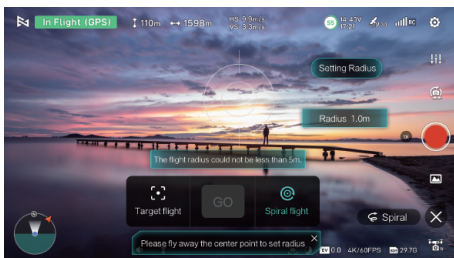
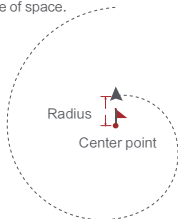

4. Tap-fly

The user can select Tap-fly in the App. Tap map to choose a destination and set flight speed, the drone will fly over there at a default speed in a straight line. If a point of interest is set, the camera will be locked at the POI.

- Tap the map to choose a destination.
- Switch to image interface to drag a rectangle around the POI.
- Set flight altitude and speed.

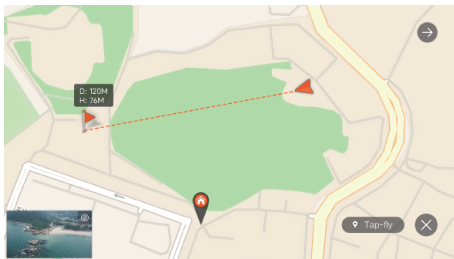

5. Waypoint

Choosing waypoint and drawing route both are available at map. The drone flies along waypoint route at a default speed. If a point of interest is set, the camera will be locked at the POI. The user can select a way to set waypoints, including choosing points in flight or on the map, historical routes.

Choosing points in flight:

- Control the drone to a point to set as a waypoint.
- Using sticks to set flight altitude and heading direction, dials to set gimbal angle, and actions when reaching the waypoint.
- When all waypoints ready, please set waypoints routes attribute, including flight speed, heading direction, action at the destination.
- POI is enabled when executing waypoints.

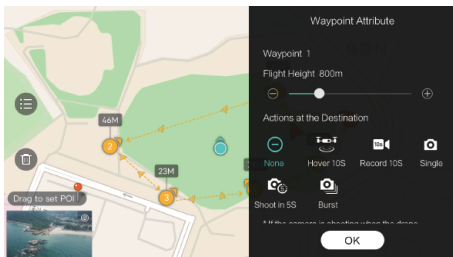

6. Precise Landing

In the process of Return to Home, the optical flow sensor will match landing pad features above the home point. Once matched successfully, the drone will land on the landing pad precisely.

Click on Settings "⚙️" -> Click on drone "🚁" -> Select Precise Landing

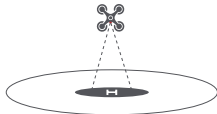

⚠️ · Please turn on this feature in the app in advance.

7. Intelligent Flight Mode

The following modes need to be used when flying in GNSS mode, short press the remote control return button "🏠" or click the App "X" to exit the mode.



Aerial Mode

When the drone is flying in GNSS mode again, you can enter the aerial photography mode in the app's mapping interface -> click 📷 -> select 📷 -> enter the aerial photography mode. In aerial mode, the braking distance of the drone is increased, the rotational angular speed is limited, the control is softer, and the shooting images are more stable and smooth.



Tripod Mode

When the drone is flying in GNSS mode again, you can enter SAR mode in the app's mapping interface -> click 📷 -> select 📷 -> enter SAR mode. The maximum flight speed of the aircraft is 1m/s, and the maximum rotation speed is 60 degrees/s. The sensitivity of the drone is reduced in tripod mode, and the shooting images are more stable and smooth.

Course Lock

When the drone is flying in GNSS mode, you can enter SAR mode by click  -> select  -> enter SAR mode in the App Mapping interface, the drone will take the current nose direction as the forward direction, and the direction is locked. You can change the nose direction and adjust the shooting angle by rocking the joystick, but the forward direction is unchanged.

Fix-wing Mode

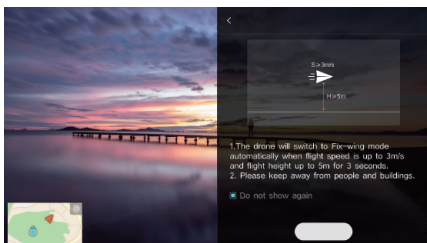

When the drone is flying in GNSS mode again, you can enter the fixed wing mode in the App mapping interface -> click  -> select  -> enter the fixed wing mode, at this time, the drone can only fly forward, can not go backward.



The user can freely control the speed and forward direction of the vehicle through the joystick. As shown below:

Left stick	push upward	up
	Push downward	down
	toggle left	turn left
	toggle right	turn right
Right stick	push upward	accelerate
	push downward	decelerate
	toggle left	turn left
	toggle right	turn right

SAR Mode

When the drone is flying in GNSS mode again, you can enter SAR mode in the App mapping interface -> click  -> select  -> enter SAR mode, at this time, the mapping interface will display the GNSS coordinates in real time, and the vehicle can help to search and rescue.

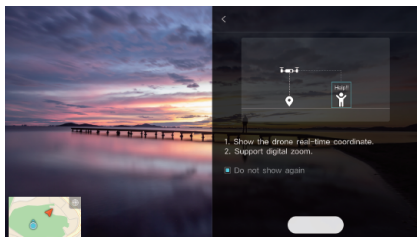

The interface of map transmission shows the coordinates of the aircraft and the current time in real time, and supports the functions of map transmission screen indentation and screenshot.

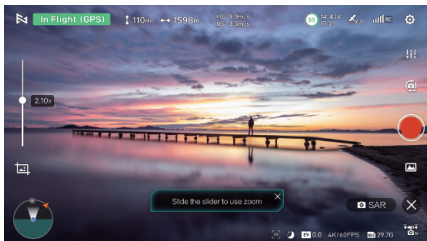

The map interface displays the coordinates of the drone and the current time in real time, and supports the function of switching satellite maps and taking screenshots.

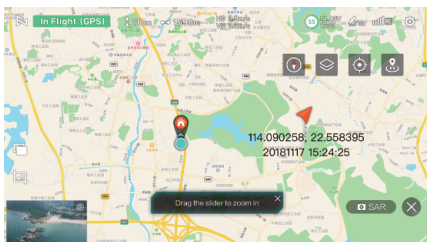

AI Super Night Video

FIMI X8 Pro 2025 is equipped with the new generation AI ISP, and the Super Night Mode has undergone a revolutionary upgrade. With ultra-sensitive noise reduction and a 4x increase in signal-to-noise ratio, it captures clear and bright images in low-light environments at night. In automatic mode, it supports a maximum ISO sensitivity of 25600.

The activation method involves the main camera image sensor detecting the ambient light levels to suggest whether the night scene mode should be activated. It can also be manually turned on or off as needed.

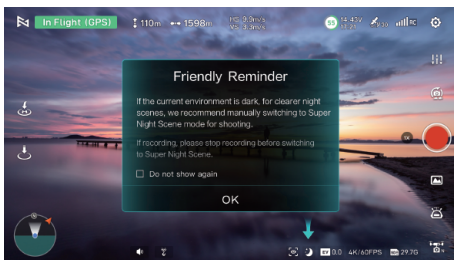

- ⚠ It is recommended to turn on this function for night shooting to get a better shooting experience.
- Night Scene mode currently only supports 24/25/30fps specifications.
- Night Scene mode does not support zoom.

Calibration

1. Compass Calibration

Pay attention to the observation according to the App prompts. Changing the flight site, the drone detects the surrounding environment requires compass calibration. Calibration steps:

- When calibration is needed, the App will pop up the calibration prompt, after calibration, the indicator light of the drone will be green and you can calibrate it.
- Rotate the drone horizontally for more than 2 turns, the interface will change to vertical calibration after successful calibration, and the indicator light of the drone will be red during the calibration process.
- Rotate the drone horizontally with the nose facing upward for more than 2 revolutions until the calibration interface indicates that the calibration is complete. The indicator light is always on green.
- Users can also trigger the compass calibration manually in App System Settings->Aircraft->Compass Calibration.

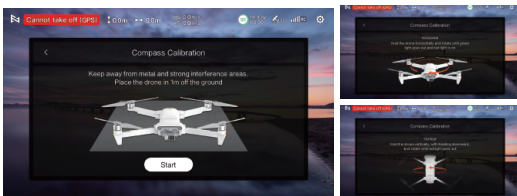

⚠ · If calibration fails multiple times, update the calibration site.

⊘ · Do not calibrate the compass with the arms retracted.

2. Gimbal Calibration

After the drone is powered on and the self-test is completed, if you find that the gimbal can not be activated or there is obvious tilt after the gimbal is activated, you need to calibrate the gimbal before taking off.

- Calibration Procedure

Gimbal trim corrects the gimbal offset by adjusting the angle of the gimbal's roll and yaw offset individually, while the calibration screen displays the vehicle's picture transmission. When the aircraft is placed on a horizontal plane and the gimbal cannot be kept horizontal with a slight tilt, it can be corrected by fine tuning.



⚠ · Please connect the airplane and gimbal before calibration, gimbal calibration can not be done in flight.

- Please choose a flat and stable environment during calibration, otherwise calibration will fail.

· Gimbal Fine-tuning

Gimbal trim corrects the gimbal offset by adjusting the angle of the gimbal's roll and yaw offset individually, while the calibration screen displays the vehicle's picture transmission. When the aircraft is placed on a horizontal plane and the gimbal cannot be kept horizontal with a slight tilt, it can be corrected by fine adjustment.

· Gimbal Fine-tuning Features

- Enter the gimbal fine-tuning interface to adjust the gimbal horizontal and yaw angle, its adjustment range is $\pm 10^\circ$. Every time you click "+/-", the angle of the gimbal will be "+0.1°/-0.1°", or you can directly input the angle value through the keyboard to adjust.
- Horizontal Adjustment: Click + to roll to the right, click - to roll to the left. Yaw Adjustment: Click + to yaw to the right, click - to yaw to the left.
- Click "Default" to return the gimbal to its default angle (0°).

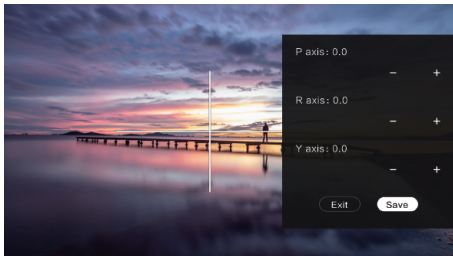

■ 3. Remote Control Calibration

When you find that the remote control operation and the drone flight response are not consistent during the flight, you can try to calibrate the remote control. Select Remote Control Calibration in APP Remote Control Settings, and click Start to enter Neutral Calibration.

- Do not touch the stick during calibration.
- After successful center calibration, skip to rocker calibration. Follow the prompts to dial the stick to maximum travel.
- After successful stick calibration, skip to roller calibration. Follow the prompts to dial the sticks to maximum travel.

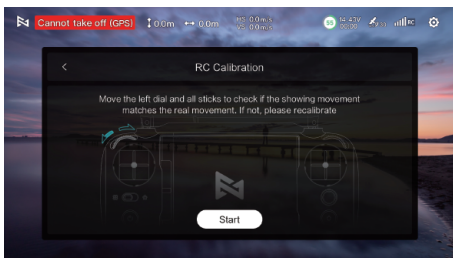

⚠ · When calibrating the remote control, please turn off the power of the aircraft; during flight, it is impossible to calibrate the remote control.

Maintenance

■ Propellers Maintenance

Propellers are wearing parts. When they're damaged, replace them in time to ensure flight safety and efficiency.

■ Battery Maintenance

Do not throw the battery into fire; Do not batter the battery; Lithium battery's capacity reduces significantly in low temperature conditions. Do not use the battery when it is below 0 degrees. Do not place the battery under the burning sun.

■ Gimbal Calibration

The gimbal of FIMI X8 Pro 2025 is an integrated gimbal and cannot be disassembled. Please be careful not to scratch the camera when storing it in the aircraft, and pay attention to the cleanliness of the camera. The gimbal is a precision component, please do not squeeze it.



■ Drone Self-check

The drone enters the self-check when the drone is powered on. If the self-check failed, App will pop up corresponding hints.

■ Firmware Upgrade

Please check the firmware version regularly, new version will be updated by Fimi Navi App to prompt users to update. Please download new firmware when the App is connected with the drone and remote controller.

Product firmware version query path:

Enter the image transmission interface, click System Settings "  "-> Pull down and select Others "  "-> Click Firmware Upgrade to view the current version

Noise test results

Observation point	Hovering	Flight 5.9m/s
Ground observation point (directly below)	77.5 dB(A)	75.2 dB(A)
Side observation point (at the same elevation level)	72.5 dB(A)	73.3 dB(A)



· The test environment is outdoor, and the testing area is a concrete surface.

FIMI Enhanced Video Transmission Module

1. Disclaimer

Thank you for purchasing our product. To protect your legal rights and interests, please carefully read the product user manual provided with this product before use. FIMI Technology Co., Ltd. (hereinafter referred to as "FIMI Technology") reserves the right to update the aforementioned documents. Before assembly, setup, and use, please visit the FIMI official website (<http://www.fimi.com>) to download the manual and read it carefully.

1. FIMI Technology shall not be liable for any consequences resulting from the purchase and maintenance of this product through unofficial channels.
2. Once you begin using this product, it is deemed that you have read, understood, acknowledged, and accepted all the terms and content of the product manual and disclaimer.
3. During the use of this product, it is imperative to strictly adhere to and execute the requirements specified in the manual. FIMI Technology is not responsible for any adverse consequences resulting from failure to carefully read the product manual or watch instructional videos.
4. Users are solely responsible for any personal injury, accidents, property damage, legal disputes arising from violations of safety instructions, or adverse events resulting from uncontrollable factors. FIMI Technology will not assume any responsibility.
5. FIMI Technology shall not be liable for any actions directly or indirectly violating applicable laws and regulations carried out by users when using this product.
6. Unauthorized modification of this product leading to property damage or personal injury will absolve FIMI Technology from any compensation and legal liability.
7. The data usage incurred by inserting a SIM card and using the 4G module is the user's own responsibility.
8. National laws and regulations impose restrictions on the flight areas of civilian drones. Users are advised to understand the local regulations before using this product for flight. Users are fully responsible for any legal liabilities arising from non-compliance with the above provisions.
9. This product should not be used in adverse weather conditions such as rain, snow, thunderstorms, strong winds, fog, or environments with strong magnetic interference. Otherwise, users will bear the losses resulting from product damage.
10. FIMI Technology does not provide free repair services for product damage caused by subjective judgment or human operational errors by users.
11. Users will bear full responsibility for fires or explosions caused by improper actions such as artificial short circuits or modifications.
12. For issues not covered in this disclaimer, please refer to relevant local laws and regulations. In case of conflict between this disclaimer and local laws and regulations, the latter shall prevail.
13. It is prohibited for individuals under the age of 16 and others who do not have full legal capacity to use this product.
14. It is prohibited to use this product in crowded places.
15. It is prohibited to use this product in areas restricted by laws or relevant regulatory authorities.
16. Please do not use this product under conditions of alcohol consumption, fatigue, influence of drugs, or other physical or mental impairments.
17. The final interpretation right of this product-related disclaimer and explanatory documents belongs to FIMI Technology.

■ 2. Overview

FIMI Enhanced Video Transmission Module can be installed as an expansion module on FIMI drones (please refer to official website information for specific supported models). In cases where the remote control signal exceeds the operating range or is obstructed, the drone can still be controlled via a 4G connection.

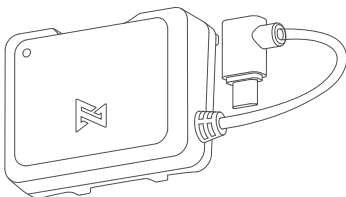

■ 3. Module Installation

Install the module as shown in the diagram:

- Unfolding the drone's arm.
- Open the interface cover.
- Follow the arrows to install the module and connect the micro USB.

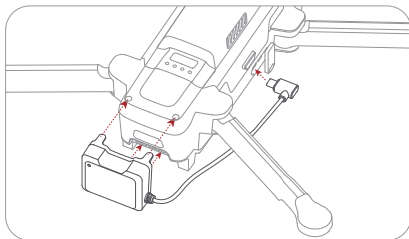

- After installation, the status should be as follows.

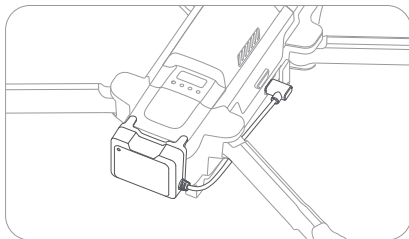

■ 4. SIM Card Installation

Install the SIM card as shown in the diagram:

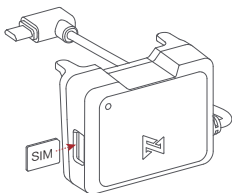

- Insert the SIM card according to the direction indicated by the red arrow.



■ 5. SIM Card Usage and Selection Instructions

- The enhanced video transmission module uses a nano SIM card.
- It is recommended to choose a SIM card from the same carrier to effectively reduce latency and improve video transmission stability.

Indicator Light Definition

Indicator Light Status	Enhanced Video Transmission Module Status
	No SIM card detected or SIM card has no network
	Network is normal
	Module is not connected to the aircraft or the aircraft is not powered on



LED is always on



LED is flashing regularly



LED is of

■ 6. Enhanced Video Transmission Usage

- Power on the aircraft and remote controller, ensuring they are properly connected.
- Enter the FIMI Navi 3.0 App video transmission interface, where the 4G signal icon will pop up in the signal display area 
- Click to view the 4G network status.



- Click the enhanced transmission switch to start using 4G enhanced transmission.



- Signal Status Indicators

 : Network connection normal, 4G signal normal, using enhanced transmission.

 : Different signal strength statuses.

 : No nanoSIM card detected or nanoSIM is inactive.

 : Enhanced transmission not in use.

 : Click to toggle enhanced transmission on/off; default is off.



- It is recommended to use the phone's native cellular network for a better experience.
- When replacing or installing a physical nano SIM card, there is no need to remove the FIMI enhanced transmission module from the drone. After replacing the nano SIM card, you need to unplug and reinsert the micro USB connection.
- After turning on enhanced transmission, be sure to monitor the transmission signal strength and ensure flight safety. Click the 4G signal icon to check signal strength.
- Enhanced transmission uses the phone's 4G network for data transfer. During use, it is advisable to turn off the phone's Wi-Fi to reduce interference and avoid affecting transmission delay and stability.
- Due to limitations of Android/iOS systems, phone calls may restrict background operations and prevent the use of the 4G network, potentially making enhanced transmission unavailable and causing the aircraft to lose connection and return.
- In urban environments with tall buildings, ensure that you set an appropriate return-to-home altitude (above buildings).
- Avoid flying beyond visual line of sight, especially at night.
- When the app indicates weak 4G transmission signal, exercise caution during flight.

7. Precautions

- The enhanced video transmission module relies on a 4G connection for video transmission, and the stability of video transmission depends entirely on the signal quality and network congestion in the current operating environment. Before flight, ensure that both the ground end (usually a smartphone) and the drone end (enhanced video transmission module) have full signal strength. Due to the inherent latency in 4G signal transmission, please observe the flying environment carefully during flight to avoid collisions with obstacles. If the drone is flying in an area with no 4G signal, it will initiate a return-to-home operation. Before flight, pay attention to the settings of the return-to-home point and altitude.
- When flying at altitudes higher than 100 meters, the quality of the 4G signal will rapidly decrease, and connection stability will be reduced. Pay attention to the flying altitude during flight.

- During normal operation, the enhanced video transmission module consumes approximately 1GB of data every 30 minutes. Please monitor data usage carefully during actual operation.
- For working frequency bands in other regions, please pay attention to the official website product instruction manual for updates.

■ 8. Specifications

Technical standard	TDD-LTE/FDD-LTE/WCDMA
Working frequency	TDD-LTE: Band 38/39/40/41 FDD-LTE: Band 1/3/5/8 WCDMA: Band 1/8
Interface	MicroUSB interface nano-SIM card interface Onboard ipex first generation antenna interface
Antenna	Built-in FPC dual antenna, supports external antenna
Dimensions	49x38x26mm (Does not include wire length)
Product Weight	19g
Input	5V \pm 1.5A
Operating temperature	Normal operating temperature: -10°C ~ +60°C Storage temperature: -20°C ~ +80°C

Basic Specification

Drone

Model: FMWRJ03A9

Dimensions: (folded, without propellers) 218 × 106 × 72.6mm
(unfolded, without propellers) 242 × 334 × 72.6mm

Takeoff Weight: Intelligent flight battery approx. 748g
Intelligent flight battery plus approx. 817g

Diagonal Distance: 372mm

Max Ascent Speed: 5m/s

Max Descent Speed: 4m/s

Max Flight Speed: 18m/s * in a windless environment at sea level

Max Takeoff Altitude: ≤ 5000m

Max Hovering Time: 29 minutes * In a windless environment, with the drone's vision turned off, camera settings adjusted to 720p/30fps, and recording mode turned off, the hover time from sea level to 0% battery remaining is measured. This is for reference only; please pay attention to the app's notifications during actual flight.

Maximum Flight Time: 38/47 minutes * In a windless environment, with the drone's vision turned off, camera settings adjusted to 720p/30fps, and recording mode turned off, the drone flew forward at a speed of 25.2 km/h from sea level until the battery reached 0%. This is for reference only; please pay attention to the app's notifications during actual flight.

Max Tilt Angle: 35°

Max Wind Speed Resistance: 12m/s

Operating Temperature Range: 0–40°C

Satellite Navigation Systems: Beidou/GPS/GLONASS/Galileo

Hovering Accuracy, Vertical: ± 0.1m (when Vision Positioning is active) ± 0.5m (when GPS is active)

Horizontal: ± 0.3m (when Vision Positioning is active) ± 0.5m (when GPS is active)

Expansion Interface: 12-PIN Data Interface (Female)

Remote Controller

Model: FMYKQ04A5

Product Weight: Approx. 373g

Dimensions: 204x91x47mm

Operating Frequency: 2.4000GHz–2.4835GHz

Max Battery Life: 8 hours *Without charging the mobile device

4 hours *Charging the mobile device

*Measured with mobile device battery level above 95%; actual results may vary depending on different mobile devices and their battery levels at the time of testing. Please refer to actual usage.

Battery Type: Li-ion

Battery Capacity: 3900mAh

Nominal Voltage: 3.7V

Input: 5V = 2A

Operating Temperature Range: 0 – 40°C

Charging Temperature Range: 5 – 40°C

(No interference, No obstruction) FCC: Approx. 20 km *The above data is measured in an outdoor open environment interference and is the farthest communication distance for one-way non-return flights under various standards. Please pay attention to the app's return prompts during actual flights.

Minimum Latency: Approx. 120 milliseconds

Supported Mobile Device Interface Types: Lightning, USB-C, Micro-USB

Wide-angle camera

Image sensor: 1/2-inch CMOS
Lens: FOV 79°
Aperture: F/1.6
Format length: 4.71mm
Format equivalent: 24 mm
Focus range: 1m to ∞
Effective pixels: 48 million
ISO range: Video automatic 100-25600/Manual 100-6400
Photo100-6400
Shutter speed: 1/8000s - 2s
Maximum photo size: 8064 × 6048
Maximum video resolution: 3840 × 2160@60/50/30/25/24fps
Maximum video bitrate: 100 Mbps
Video format: MP4
File systems: FAT32/exFAT
Photo formats: JPG, JPG+DNG
Digital zoom: 1-5x

Gimbal

Three-axis mechanical gimbal (Pitch, Roll, Yaw)
Structural design range: Pitch: -115° to 40° Roll: -40° to 40° Yaw: -40° to 40°
Controllable rotation range: 10° to -90° (pitch)
Angular vibration range: ± 0.005°

Downward Positioning

Monocular Optical Flow, TOF Distance Measurement
Accurate measurement range: 0.3 m to 6 m
Downward auxiliary light: Dual LED *Surface with diffuse reflection material, rich surface texture, reflectivity greater than 20% (e.g., concrete surface), adequate lighting conditions (greater than 15 lux, typical indoor daylight illumination).

Intelligent Flight Battery

Model: DC03A5
Capacity: 4650mAh
Weight: Approx. 260g
Nominal Voltage: 11.55V
Charging Limit voltage: 13.2V
Energy: 53.7Wh
Battery Type: Li-Po 3S
Charging Ambient Temperature: 0-40°C

Intelligent Flight Battery Plus

Model: DC04A3
Capacity: 5000mAh
Weight: Approx. 330g
Nominal Voltage: 14.4V
Charging Limit voltage: 16.8V
Energy: 72Wh
Battery type: Li-ion 4S
Charging Ambient Temperature: 0-40°C

Smart charging Case

Input USB-C: 5V-20V

Fast Charging Protocol: Support PD, QC3.0

Output (Charging) Battery interface: 13.05V-17.6V

Operating Temperature: 5-40°C

Charger

Input: 100V-240V (AC) , 50-60Hz, 1.5A

Output USB-C: 5.0V = 3.0A, 9.0V = 3.0A

12.0V = 3.0A, 15.0V = 3.0A

20.0V = 2.25A

Rated power: 45W

Recommended SD Card List:

SanDisk Extreme PRO 32GB V30 U3 A1 microSDHC

SanDisk Extreme PRO 64GB V30 U3 A1 microSDHC

SanDisk Extreme PRO 128GB V30 U3 A1 microSDHC

SanDisk Extreme PRO 256GB V30 U3 A1 microSDHC

Lexar 1066x 64GB V30 U3 A2 microSDXC

Lexar 1066x 128GB V30 U3 A2 microSDXC

Lexar 1066x 256GB V30 U3 A2 microSDXC

Lexar 1066x 512GB V30 U3 A2 microSDXC

Kingston Canvas GO! Plus 64GB V30 U3 A2 microSDXC

Kingston Canvas GO! Plus 128GB V30 U3 A2 microSDXC

Kingston Canvas React Plus 64GB V90 U3 A1 microSDXC

Kingston Canvas React Plus 128GB V90 U3 A1 microSDXC

Kingston Canvas React Plus 256GB V90 U3 A1 microSDXC

Samsung EVO Plus 512GB V30 U3 A2 microSDXC

APP

FIMI Navi 3.0 Mobile Device System Requirements: iOS 12.0 or later , Android 9.0 or later



This manual may be updated without further notice. Please visit the Fimi official website for the latest version: <https://www.fimi.com>

This manual introduces the high-performance version of the battery and charging kit. Please refer to the actual purchase for specific specifications.