

FIMI MINI 3 SE

User Manual **V1.1** 2024.11

Revision Log





Version	Date	Revision Content
V1.0	2024.8	First Edition Release
V1.1	2024.11	Update on Video Modes and Precautions for Using the Sport Mode

Table of Contents

Reading Tips	03	FIMI Navi Mini App	24
Description Of Symbols	03	Flight Data	24
Services & Support	03	Main Page Display	24
		Main Page Function Introduction	25
Product Introduction	04	Gesture Operations	25
Product and Accessories	04	Image Interface	26
Function Overview	04		
Drone Component Names	05	Safety Protection	31
Remote Controller Component Names	06	Auto-return	31
		Low-power Protection	31
Prepare	07	Hovering On The Edge of No-fly-zone	31
Prepare The Drone	07	Height And Distance Limitations	32
Prepare The Remote Controller	08	Flight Environment Requirements	32
		Pre-flight Inspection	33
Drone	09	Novice Mode	33
Power On/Off The Drone	09		
Flight Mode	09	Flight	34
Downward Vision System	10	Basic Flight	34
Flight Mode	11	Take Off/Landing	34
Drone Light	12	Basic Flight Operations	35
		Stop Propellers In An Emergency	35
Intelligent Flight Battery	13	Automatic Take-off/Landing/Return	36
Intelligent Flight Battery Features	13		
Intelligent Flight Battery Usage	14	Intelligent Flight	38
		Follow3.0	38
Installation and Removal	15	Orbit A Point Flight	39
Propeller	15	Spiral Flight	40
Installation Intelligent Battery	16	Tap-fly	40
Insert Micro SD card	16	Waypoint	41
Equip And Remove The Gimbal Protector	16	Precise Landing	41
		Intelligent Flight Mode	41
Gimbal Camera	17		
Working Mode	17	One-Tap Short Film	44
Camera Overview	18	One-Tap Short Film Mode	44
Image Storage and Export Methods	18	Launching One-Tap Short Film	44
Remote controller	19	Calibration	46
Operation And Usage	19	Compass Calibration	46
Remote Controller Button Shortcuts	20	Gimbal Calibration	46
Remote Controller Indicator Lights	21	Remote Control Calibration	47
Remote Control Alerts	22		
Remote Controller Communication Range	22	Maintenance	48
Remote Controller Pairing	23		
		Basic Specifications	49

Reading Tips

■ 1. Description Of Symbols

-  · Operation prohibited
-  · Important notes
-  · Operation, Usage tips
-  · Glossary, Reference Information

■ 2. Services & Support

FIMI provides FIMI MINI 3 SE users with tutorial videos and the following information :

1. 《FIMI MINI 3 SE User Manual》
2. 《FIMI MINI 3 SE Quick Start Manual》
3. 《FIMI MINI 3 SE Disclaimer and Safety Operation Instructions》

Users are advised to watch tutorial videos before using the product and read FIMI MINI 3 SE Disclaimer and Safety Operation Instructions carefully and get to know the process of using by going through FIMI MINI 3 SE Quick Start Manual. For more detailed product information, please refer to FIMI MINI 3 SE User Manual. Please download the firmware on the link below : <https://www.fimi.com>

4. Please scan the the following QR-code to download FIMI Navi Mini App



Product Introduction

FIMI MINI 3 SE is a highly integrated, foldable, small quadcopter featuring long endurance, strong wind resistance, and a body weight of less than 250g. Its dual-axis high-precision mechanical gimbal, combined with electronic stabilization and a high-speed image processing chip, allows the camera to capture stable and smooth 4K/30fps footage. With HD real-time image transmission, it is ideal for beyond-visual-line-of-sight (BVLOS) flights, and its compact design, combined with the remote controller, makes it easy to carry.

The drone is equipped with an intelligent flight battery, offering a maximum flight time of about 32 minutes. The app interface is simple and user-friendly, ensuring a more effortless flying experience.

■ 1. Product And Accessories



- 💡 · This section displays the standard version of the product; please refer to the actual purchased kit for specifics.
- The drone's propellers come pre-installed from the factory, so no additional installation is required.

■ 2. Function Overview

· Gimbal Camera Performance

The camera is equipped with a 1/2.5-inch Sony CMOS image sensor, paired with a hybrid gimbal combining mechanical and electronic stabilization, enabling the capture of stable 4K 30fps HD videos. It supports both horizontal and vertical shooting modes to meet various photography needs.

· Image Transmission Performance:

Using the new SoLink HD digital transmission technology, it can achieve a maximum communication distance of up to 9 km in an interference-free and unobstructed environment, with up to 720p 30fps HD real-time transmission. It supports dual-band switching between 2.4 GHz and 5.8 GHz, with advanced encoding and decoding technology reducing transmission latency to as low as 120 milliseconds.

· Intelligent Flight Features:

New SoC technology with powerful computing capabilities can recognize and track up to 30 types of targets including people, vehicles, boats, and animals. Intelligent flight functions such as Route Flight, Follow 3.0, Waypoint Flight, and Spiral Flight make it easy to capture impressive footage.

- ⚠️ · The maximum flight speed of the drone is measured in a windless environment near sea level.
- The longest flight time is measured in a windless environment at a constant speed of 21.6 km/h (6 m/s), with recording off and battery at 0%.
- In open, unobstructed, and electromagnetically interference-free environments, and at a flight altitude of approximately 120 meters, the maximum communication distance of the remote controller can be reached under FCC standards (one-way, without return-to-home).
- Some countries and regions do not support the 5.8 GHz frequency band; please understand local laws and regulations before use.

■ 3. Drone Component Names

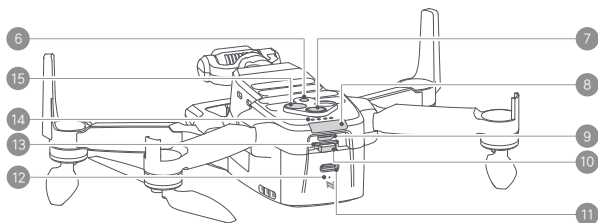
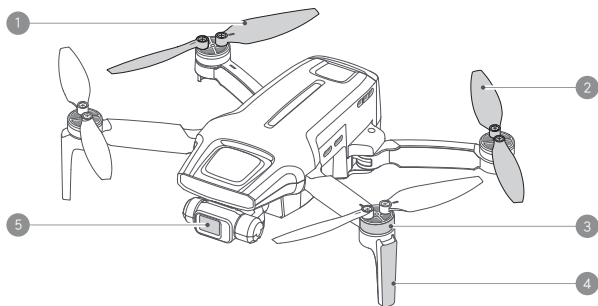

- | | | |
|-------------------------------|---------------------------|------------------------------|
| 1. Clockwise propeller | 6. Downward vision system | 11. Charging port |
| 2. Counterclockwise propeller | 7. Power button | 12. Charging Indicator Light |
| 3. Brushless motor | 8. Flight status light | 13. SD card slot |
| 4. Antenna stand | 9. Micro USB port | 14. Battery Indicator light |
| 5. Integrated Gimbal Camera | 10. Battery unlock button | 15. TOF sensor |

■ 4. Remote Controller Component Names

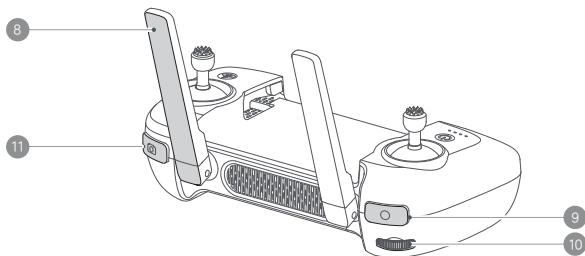
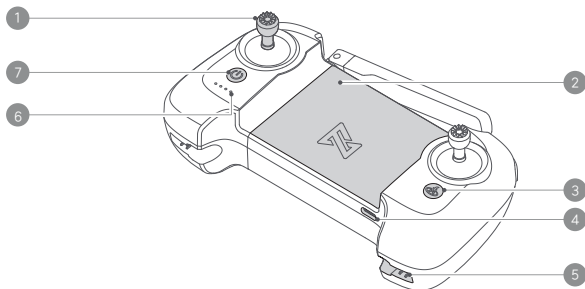

1. Joystick
2. Mobile holder *For securing mobile devices
3. Auto return *Press and hold for more than two seconds for automatic return; press briefly to cancel
4. TYPE-C port *Charge the remote controller / Connect the mobile device
5. Stick storage slot *One on each side, used to store the Joysticks
6. Battery level lights *Indicates the remote controller's battery level and other statuses
7. Power button *Short press to turn on/off the device, and long press for two seconds
8. Antenna *Dual antennas are foldable
9. Record button *Short press to start/stop recording
10. Dial *Moving the levers left and right adjusts the gimbal's pitch angle for shooting
11. Shoot button *Press briefly to take a photo

Prepare

The drone is in a folded state when it is shipped. Please follow these steps to unfold the drone.

■ 1. Prepare The Drone

- Remove the propeller tie

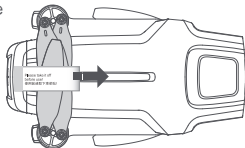

- Unfold the drone. First, unfold the front arms, then unfold the rear arms, and extend all the propellers

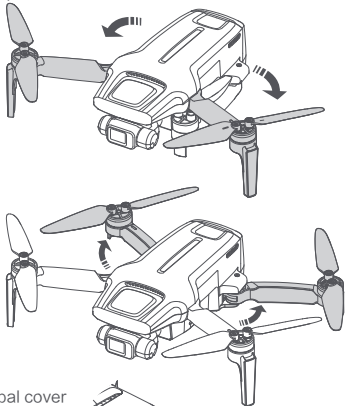

- Remove the gimbal cover

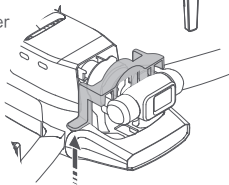

· Before powering on the drone, ensure that the gimbal protector has been removed and that both the front and rear arms are unfolded to avoid affecting the drone's self-check.

· When not using the drone, it is recommended to install the gimbal protector.

■ 2. Prepare The Remote Controller

- Remove the joysticks from the storage slots and screw them into the remote controller in a clockwise direction.

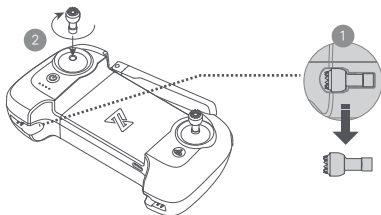

- Extend the antennas



· Remote Controller Device Installation

1. Connect the data cable to the phone interface following the arrow direction.
2. Insert the data cable into the remote controller interface following the arrow direction.
3. Pull the remote controller apart in the direction of the arrows to secure the mobile device.

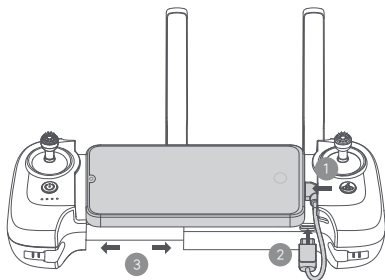

Drone

FIMI MINI 3 SE drone primarily consists of the flight control system, communication system, vision system, power system, and intelligent flight battery.

Vocabulary Explanation

IMU	Inertial Measurement Unit (IMU), the most crucial core sensor of the drone
TOF(Time of Flight)	Flight time measurement, which determines the target distance by detecting the time it takes for an infrared signal to travel from the transmitter to the receiver
Downward vision system	Refers to the sensor system composed of the camera and TOF module located on the bottom of the aircraft
Visual positioning	Refers to the high-precision positioning capability achieved through the downward vision system
Compass	Geomagnetic sensor, which helps the drone identify its orientation
Barometer	Barometric pressure sensor, which helps the drone determine its altitude based on atmospheric pressure
GNSS	Global Navigation Satellite System

■ 1. Power On/Off The Drone

- Press briefly + long press for 2 seconds to power on/off.
- Press briefly to check battery level.

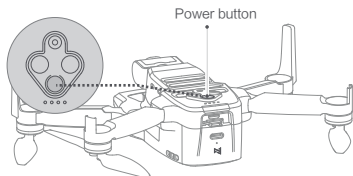

■ 2. Flight Mode

- GPS Mode (Standard)

In GPS Mode (Standard), the drone uses the GPS module for precise hovering and supports intelligent flight features. Users can select either Sport Mode or Beginner Mode in the App. In Beginner Mode, the flight controller restricts flight speed, distance, altitude, and return-to-home altitude. In Sport Mode, the maximum flight speed is 16 m/s, the maximum ascent speed is 5 m/s, and the maximum descent speed is 3.5 m/s.



- VPU Mode (Optical Flow)

In VPU (Optical Flow) mode, precise hovering is achieved using the optical flow module, and intelligent flight functions are not supported. The maximum flight speed is 10 m/s, the maximum ascent speed is 3 m/s, and the maximum descent speed is 2 m/s. Switch to VPU mode when flying indoors or when GPS signals are weak and ground textures are clear outdoors.



· ATTI Mode (Attitude)

In ATTI (Attitude) mode, when GPS or optical flow signals are weak, the drone will rely on its internal sensors for orientation and altitude control. The maximum flying speed is 16m/s, with a maximum ascent speed of 5 m/s and a maximum descent speed of 3.5 m/s. In ATTI mode, the drone may drift horizontally and does not support intelligent flight features. To avoid accidents, users should fly in locations with strong GPS signals and open spaces. If the drone enters ATTI mode, land it as soon as possible to a safe location.

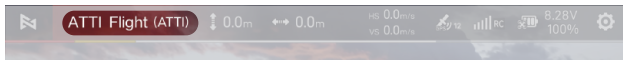

■ 3. Downward Vision System

The product is equipped with a downward-facing sensing system consisting of a monocular camera and a TOF (Time-of-Flight) module. The TOF module includes both an emitter and a receiver, which measure the time taken for infrared signals to travel from emission to reception and reflection, thereby calculating the drone's precise altitude relative to the ground. Combined with the monocular camera, this system enables high-precision low-altitude positioning of the drone.

· Sensing Range

Downward Sensing System: Operates within a height range of 0.3 to 15 meters, with an effective detection range of 0.3 to 5 meters for precise distance measurement. Automatically activates when visual positioning conditions are met.

· Usage Scenarios

The downward vision system's positioning function automatically activates in environments with poor or no GNSS signals. When using visual positioning for flight, the drone will actively limit its flight speed to ensure positioning accuracy and flight safety.

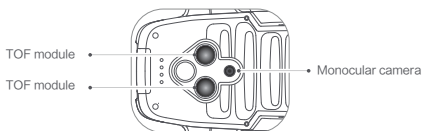

- Users should always be aware of their surroundings and follow relevant warnings from the FIMI Navi Mini App during flight, maintaining full control of the drone and being responsible for their actions.
- In the absence of GNSS signals, when using the visual system in open and flat areas, the optimal working height range for the visual positioning system is 0.5–15 meters. Flying outside this range may decrease positioning performance, so exercise caution.
- The visual system may not recognize surfaces without texture features and may not function correctly in environments with insufficient or excessive lighting.
- The vision perception system may not work properly in the following scenarios:
 - a. Plain color surfaces (e.g., pure black, pure white, pure green).
 - b. Surfaces with strong reflections or reflections.
 - e. Scenes with rapidly changing lighting conditions.
 - f. Surfaces that are very dark (lighting less than 10 lux) or very bright (lighting greater than 40,000 lux).
 - g. Surfaces with strong infrared absorption or reflection (e.g., mirrors).
 - i. Surfaces with highly repetitive textures (e.g., small checkered tiles of the same color).
- Do not obstruct the downward-facing camera and infrared sensors in any way. If they become dirty, clean them promptly. If damaged, contact after-sales service for repair.

■ 4. Flight Mode

The drone supports the following flight modes, which can be switched using the flight mode¹ "FC" button in the app.

· Cine

The cine mode limits the maximum flight speed, ascent, and descent speeds compared to the cine mode, making the drone more stable during shooting.



· Normal

When you become proficient in flying, you can manually switch to the Standard mode, which is the most commonly used mode. With obstacle avoidance enabled and environmental conditions meeting the visual system's requirements, the maximum flight attitude angle is 30°, and the maximum horizontal flight speed is 14m/s.



· Sport

In good GNSS conditions, to achieve a stronger flying experience, the maximum horizontal flight speed will be increased to 16m/s.



- At altitudes above 2400 meters, the Sport mode will be disabled.
- The default factory setting is the Standard mode.



- When using Sport mode, the flight speed of the drone will significantly increase compared to Standard mode, which also results in a much longer braking distance. Please fly cautiously to ensure safety.
- In Sport mode, the drone's attitude control sensitivity will be significantly increased compared to Standard mode, meaning that small movements of the joystick on the remote control will result in more pronounced flight actions.
- In windy conditions, limitations will be lifted to enhance the drone's wind resistance, which may result in gimbal shaking in the footage.
- Videos recorded in Sport mode may exhibit slight shakiness.
- Battery level below 20%, sports mode is not supported.

■ 5. Drone Light

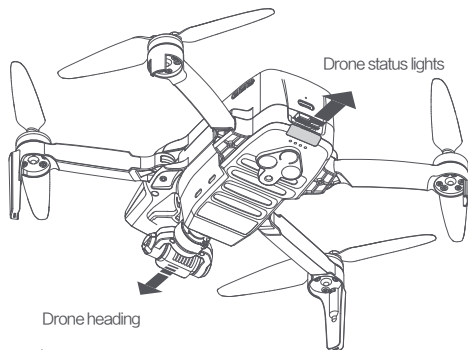

	Light status	Drone status
1	The yellow light is fading in and out	Self-checking
2	Red light on	Drone on the ground: Self-check fails
		Drone is flying: Attitude Mode
3	Red and yellow lights flash alternately	Calibrate the compass
4	Green light flashing twice	Ready to fly/in flight
5	Red light flashing twice	Low battery alerts
6	Red light flashing quickly	Very low battery alerts, land as soon as possible
7	Red and green lights flash alternately	Updating firmware
8	All lights off	The drone is paring to the RC

Intelligent Flight Battery

FIMI MINI 3 SE Smart Flight Battery (DC05A7) has a capacity of 2200 mAh and a rated voltage of 7.7 V. It features charge and discharge management functions, independent charging, a TYPE-C charging port, high-energy cells, and an advanced battery management system.

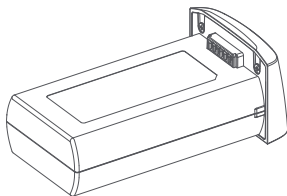

■ 1. Intelligent Flight Battery Features

- **Balancing Protection:** Automatically balances the voltage of the internal battery cells to protect the battery.
- **Overcharge Protection:** Prevents serious damage to the battery by stopping charging once the battery is fully charged.
- **Charging Temperature Protection:** Charging the battery at temperatures below 5°C or above 40°C can damage the battery. Charging will not start at these temperatures. If the battery cell temperature rises to 45°C or above during charging, charging will stop.
- **Overcurrent Protection:** Large current charging will seriously damage the battery. If the charging current is too high, the battery will stop charging.
- **Over-discharge Protection:** Over-discharging will seriously damage the battery. When the battery is not used for flight, it will cut off output when discharged to a certain voltage. Over-discharge protection is not activated during flight.
- **Short Circuit Protection:** The battery will instantly cut off output in the event of a short circuit to protect the battery.
- **Cell Damage Detection:** If the battery detects cell damage or severe imbalance, it will indicate that the battery is damaged.
- **Sleep Protection:** When not in flight, the battery will automatically enter sleep mode to prevent over-discharge. The battery needs to be charged before use to exit sleep protection.
- **Communication:** The aircraft can obtain real-time battery information such as voltage, capacity, and current through the communication interface on the battery.



• The smart flight battery needs to be charged for activation before its first use.



- After the flight, the smart flight battery temperature is relatively high, so it must be allowed to cool down to room temperature before charging.
- Recharge the battery every three months or so to maintain battery activity. Batteries that have not been maintained (charged and discharged) for over three months are not covered under warranty.
- It is recommended to store the battery and the aircraft separately if not in use for a long time.



• Do not touch the metal ports with your hands or other objects.

■ 2. Intelligent Flight Battery Usage

· Check battery level

When the battery is inserted into the drone, short-press the drone's power button to check the current battery level.

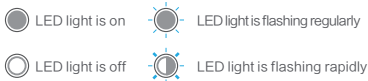
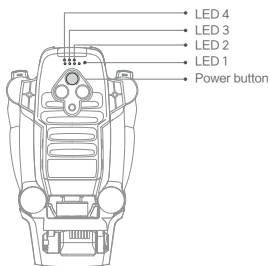

battery level	LED 1	LED 2	LED 3	LED 4
100%	●	●	●	●
75%-99%	●	●	●	●
50%-74%	●	●	●	○
25%-49%	●	●	○	○
0%-24%	●	○	○	○

· Low-Temperature Usage Precautions

- In low-temperature environments (from -5°C to 10°C), ensure that the battery is fully charged. The battery's discharge capability will be reduced in cold conditions. Start the drone to warm up the battery before takeoff (follow the app's prompts).
- The battery cannot be used for flying in environments below -5°C .
- In cold conditions, it is recommended to preheat the battery to above 10°C before flying, with 20°C being ideal.
- In low temperatures, the battery's output power is limited, which can reduce the drone's wind resistance. Operate with caution.
- Extra caution is needed when flying in low-temperature high-altitude environments.

· Charging

- As shown in the image, connect the charging cable to the battery charging port.
- During charging, the battery indicator light will stay on.
- When charging is complete, the battery indicator light will turn off.
- Charging the drone battery to full: With 5V/2A takes approximately 2.5 hours, With 9V/2A takes approximately 1.5 hours, With 9V/3A takes approximately 1 hour.

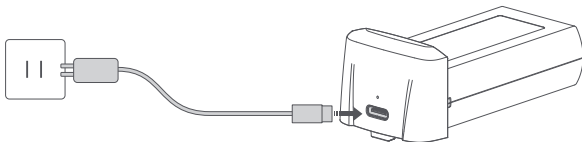





- Battery charging time depends on the power of the charger. To ensure faster charging, it is recommended to use a USB charger with QC2.0 or higher protocol; PD fast charging is not supported.
- The permissible charging temperature range for the battery is 5°C to 40°C . If the battery's temperature falls outside this range, charging will not be possible.

Installation and Removal

1. Propeller

The propellers on the drone motors are designated as clockwise (CW) and counterclockwise (CCW). The two propellers on the same motor are identical, with marked and unmarked propellers indicating different rotational directions. Be sure to follow the instructions strictly, installing the different propellers in their corresponding positions.

	propellers	Installation Instructions	Installation Diagram
Marked		Install marked propellers on the marked arms	
Unmarked		Install unmarked propellers on the unmarked arms	

• Installation propellers

- Please install and remove propellers as the picture shown.
- When installing, match the markings on the arms and propellers to ensure correct assembly and distinguish between the clockwise and counterclockwise propellers (illustrated as clockwise propellers).
- To ensure proper usage, please replace the corresponding screws along with the propellers when changing them.

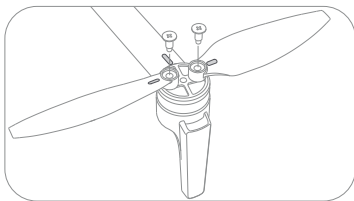

- The accessory pack includes a specialized screwdriver, spare propellers, and screws.
- When installing or removing propellers, it is easier to hold the motor with your hand.



- When replacing propellers, always use official screws to ensure they are tightened vertically.
- If a propeller is damaged, replace both the propeller and screws on that motor.
- Propellers are consumables; purchase replacements as needed.
- Avoid coming close to spinning propellers to prevent injury.
- If you experience flight instability, reduced speed, or shorter battery life, check the propellers. Replace them if they are damaged or deformed.
- Ensure there are no foreign objects inside the motor, and that it rotates freely and silently. Replace the motor if it makes unusual noises.



- Never insert a screwdriver or other sharp objects into the motor ventilation holes, as this could severely damage the motor.
- Do not block the motor ventilation holes or the ventilation holes on the drone's body.
- Do not modify the physical structure of the motor.

■ 2. Installation Intelligent Battery

- Hardly push the battery, after the battery installed in place, there will be a "click" sound.
- To remove the battery, you need to press the bottom buckle to pull out the battery.

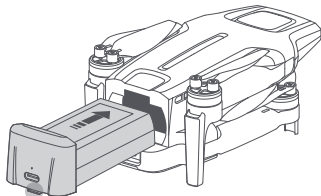

Battery buckle

 Please ensure the battery is properly installed, as improper installation could pose a flight safety risk.

■ 3. Insert Micro SD card

- When installing Micro SD card, please pull out the battery.
- Insert the SD card into the SD card slot.
- When removing SD card, press the SD card to pop out.

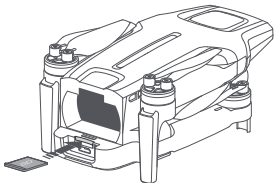

■ 4. Equip And Remove The Gimbal Protector

- Equip and remove the gimbal protector as shown

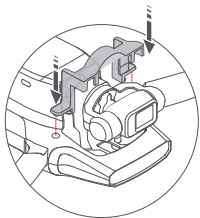

Equip the gimbal protector as the arrow leading

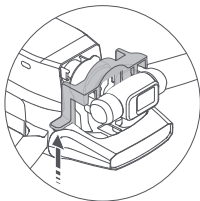

Remove the gimbal protector as the arrow leading

Gimbal Camera

FIMI MINI 3 SE camera features a 1/2.5-inch Sony CMOS image sensor, combined with a mechanical plus electronic stabilization gimbal, enabling stable 4K/30fps video capture. It supports both horizontal and vertical shooting modes to meet different filming needs.

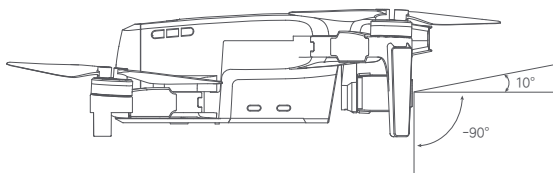

■ 1. Working Mode

The gimbal can operate in Follow Mode and FPV Mode to suit different shooting needs. FPV mode can be selected in the FIMI Navi Mini App interface by navigating to Image Transmission -> Intelligent Flight -> Flight Mode -> Fixed-Wing.

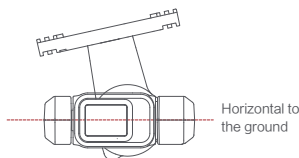

Follow:

The angle between the gimbal's orientation and aircraft front remains constant at all times.

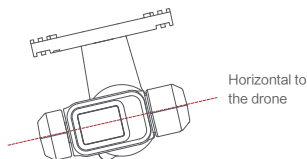

FPV:

The gimbal synchronizes with the movement of the aircraft to provide a first-person flying experience.

- ⚠ Before takeoff, ensure there are no objects on the gimbal and place the drone on a flat, open surface. Avoid touching the gimbal after the power is turned on.
- The gimbal contains precision components. If it is bumped or damaged, these components may be harmed, which could lead to decreased gimbal performance. Handle the camera gimbal carefully to avoid physical damage.
- Keep the gimbal clean and avoid contact with sand, stones, or other foreign objects, as these could obstruct the gimbal's movement and affect its performance.
- Do not apply force to the gimbal after powering on.
- Do not attach any objects to the camera gimbal, as this could affect its performance or even damage the motor.
- Remove the gimbal protector before turning on the device. Reinstall the gimbal protector during storage or transportation to protect the gimbal.

2. Camera Overview

FIMI MINI 3 SE camera features a 1/2.5-inch Sony CMOS sensor with a resolution of up to 12 million effective pixels and an equivalent focal length of approximately 18 mm. The lens has an aperture of F2.2 and a shooting range from 0.8 m to infinity. The FIMI Mini 3 SE can record up to 4K/30fps high-definition video.

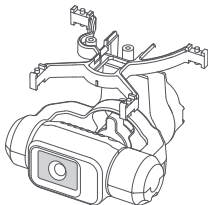

- ⚠ Do not expose the camera lens to laser beams (such as from laser shows) to avoid damaging the camera sensor.
- Use and store the camera within the specified temperature and humidity ranges to maintain optimal lens performance.
- To clean dirt or dust from the lens surface, use professional lens cleaning tools to avoid affecting the image quality.

3. Image Storage and Export Methods

• Storage

FIMI Mini 3 SE is equipped with a Micro SD card slot for expanded storage. For high-quality video/photo recording, the storage device must support fast write speeds. Please use a UHS-I Speed Grade 3 or higher MicroSD card to ensure optimal recording performance. Refer to the FIMI official website for the recommended list of MicroSD cards. Without a MicroSD card inserted, you will not be able to capture photos or videos.

• Export

After removing the microSD card from the drone, insert it into a card reader to export the image data. Alternatively, you can download the original photos and video files from the media library in the app.

• Micro SD Card Specifications

- File Format: FAT32, exFAT
- Capacity: 8GB to 512GB
- Speed Requirement: It is recommended to use an SD card with a U3 (UHS Speed Class 3) rating or higher

- 💡 The video files downloaded from the media library may have different resolutions compared to the original transmission video. For higher-quality videos, please use a computer or other devices to read the MicroSD card.

- ⚠ Using some U1/C10 Micro SD cards may result in a slow card warning due to their low write speed.
- Do not insert or remove the MicroSD card during recording. Doing so may damage the card and result in data loss.
- Before using the device for important recordings, conduct several test shoots to ensure the equipment is functioning correctly.
- Make sure to properly shut down the smart flight battery; otherwise, camera settings may not be saved and recorded videos may be corrupted. FIMI is not responsible for any losses due to unreadable videos or photos.

Remote controller

FMYKQ04A3 remote controller, used with the FIMI Mini 3 SE, is equipped with SoLink transmission, supporting dual-frequency bands of 2.4 GHz and 5.8 GHz. It supports real-time transmission of 720p/30fps high-definition video. In an environment with no obstructions and minimal interference, it can operate the drone and camera up to a maximum distance of 9 km. The remote controller's joysticks are detachable, and the battery has a capacity of 3500 mAh, providing up to approximately 4 hours of operation when connected to a mobile phone.

■ 1. Operation And Usage

- Power On/Off
 - Short press + Long press the power button for 2 seconds to turn the remote controller on or off.
 - Short press the power button to check the battery level.
- Controller Functions

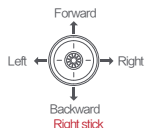
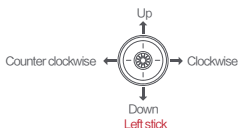
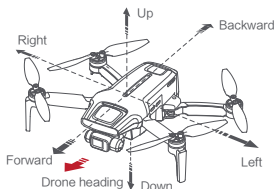
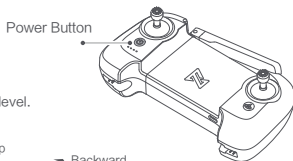

	Buttons	Function description
1	Left stick	Push stick forward to ascend Pull stick backward to descend Move stick left & right to Yaw CCW Move stick right to Yaw CW
2	Right stick	Push stick forward to Pitch (fly) drone forward Pull stick backwards to Pitch (fly) drone backwards Move stick left to Roll (fly) drone left Move stick right to Roll (fly) drone right
3	RTH (Return to Home)	Long press the button for over 2 seconds, and the drone will enter RTH mode when you hear a beep. Short press the button to cancel RTH mode
4	Photo button	Short press to shoot the picture
5	Video button	Short press to start / stop recording
6	Dial	Adjust the pitch angle of gimbal camera
7	Power button	Short press to view the battery level Short press+long press 2 seconds to power on/off



The settings for the remote control sticks can be adjusted in the remote control settings menu (default is for American hands).

· Sticks Control

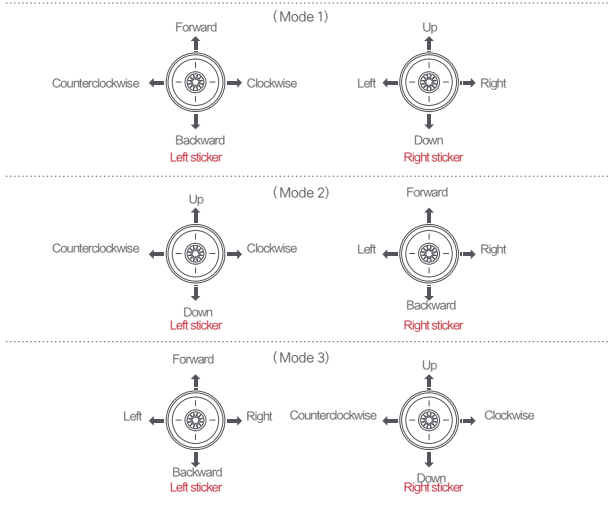

■ 2. Remote Controller Button Shortcuts

- Press the photo button once, and after hearing two short beeps, the camera will take a photo.
- Press the video button once to start recording; press it again, and after hearing four short beeps, recording will stop.
- The scroll wheel can be used to adjust the tilt angle of the gimbal by moving it left or right.

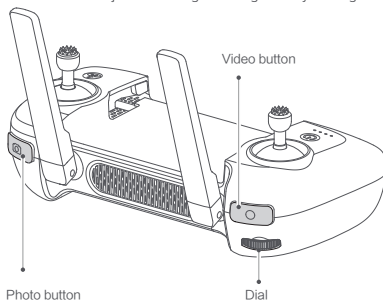

3. Remote Controller Indicator Lights

As shown in the diagram, the remote controller is equipped with four white LED lights that indicate battery level and other statuses.

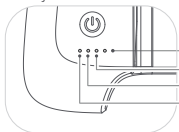

· Light status of remote controller

Remote lights	Remote status
Short press the power button	Check battery level
Fade in and out	Not connected to the drone
Flash in turn	Pairing or updating the firmware
Light keeps on	Connection normal

· Remote Controller Battery Level Display

LED1	LED2	LED3	LED4	Battery level
●	●	●	●	75% < Battery level ≤ 100%
●	●	●	○	50% < Battery level ≤ 74%
●	●	○	○	25% < Battery level ≤ 49%
●	○	○	○	10% < Battery level ≤ 24%
●	○	○	○	The remote controller beeps to warn that the battery level is less than 10%.

· Charging

- Connect the remote controller to a power adapter as shown below.
- When the RC is in charge, the battery level lights are flashing.
- When the RC is fully charged, the battery level lights go out.
- It takes about 2.5 hours to fully charge the RC in the powered off condition.

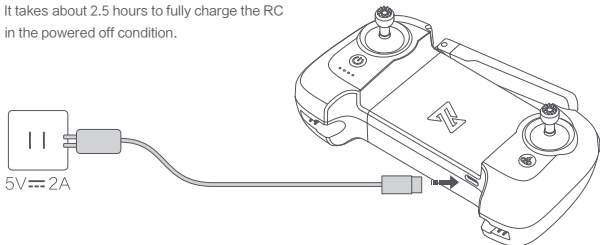

· Remote controller charging indicator status

LED1	LED2	LED3	LED4	Current Battery Level
				0%-25%
				25%-50%
				50%-75%
				75%-99%
				99%-100%

■ 4. Remote Control Alerts

In certain scenarios or when the remote control encounters an error, it will emit continuous "beep" alerts. For specific details, refer to the real-time prompts in the FIMI Navi Mini App. The return-to-home alert sound cannot be disabled. The low battery alert at less than 10% cannot be disabled, and when the battery level drops below 3%, the urgent alert sound cannot be disabled.

■ 5. Remote Controller Communication Range

- When operating the aircraft, it's important to promptly adjust the orientation and distance between the remote controller and the aircraft, as well as adjust the antenna position to ensure the aircraft remains within optimal communication range.
- When the antenna forms a 180° or 270° angle with the back of the remote controller, and the antenna plane is directly facing the aircraft, it can optimize the signal quality between the remote controller and the aircraft.

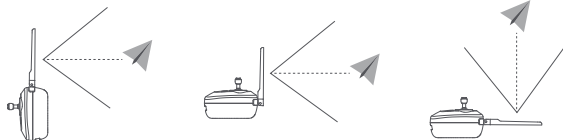

- Do not use other communication devices on the same frequency band simultaneously to avoid interference with the remote control signal.
- During actual operation, if the FIMI Navi Mini App indicates poor image transmission signal, please adjust the antenna position according to the prompt to ensure the aircraft is within the optimal communication range.

6. Remote Controller Pairing

The remote controller and the drone are paired at the factory and can be used directly after powering on. When replacing with new equipment, re-pairing is required to use. The steps are as follows:

- Turn on the drone and remote controller.
- Wait for 20 seconds, then long press the power button of controller until hearing the beep sound, and the light will be flashing.
- Long press the power button of the drone till the tail light off.
- The code pairing succeeds when the power button on the RC turns white and the tail light on the drone keeps on.

Long press the power button

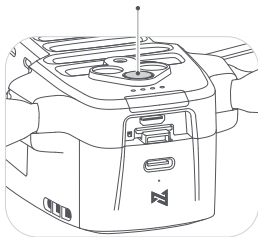

Long press the power button

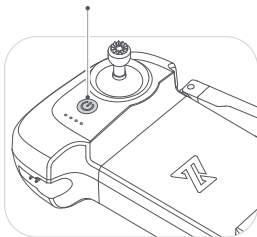

- Please ensure the drone and the RC stay within 0.5m while pairing.
- Ensure the battery level of drone and RC are more than 30%.

FIMI Navi Mini App

- FIMI Navi Mini App interface and specific functions may vary slightly with app version updates. Please refer to the actual version used for the specific interface and functions.

1. Flight Data

- The FIMI Navi Mini App has a flight data recording feature that allows users to view their flight data within the app.
- Flight records can capture basic data for each flight.
- Flight logs will record detailed flight data.
- If users encounter issues during a flight, they can provide feedback within the app, and if necessary, upload flight logs to receive assistance.
- After downloading the app, the first use will direct you to the login page.

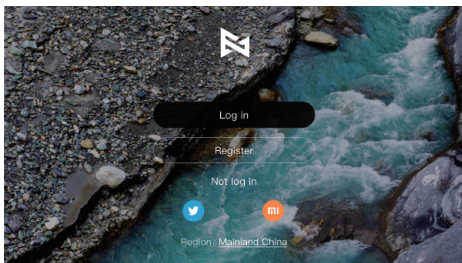

- Using the FIMI Navi Mini App without logging in will restrict access to some features, such as flight data recording, dynamic no-fly zone requests, and FIMI's flexible exchange service.
- For a complete service experience, logging in is recommended.
- All flight data is stored on the user's mobile device, and the company will not access any of your flight data unless you actively upload it to the cloud.

2. Main Page Display

Swipe left or right to select the desired drone model. If the remote controller is connected, it will automatically switch to the corresponding model.

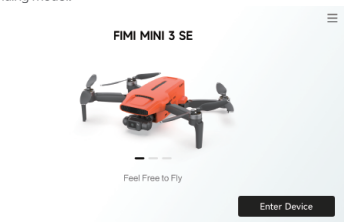

3. Main Page Function Introduction

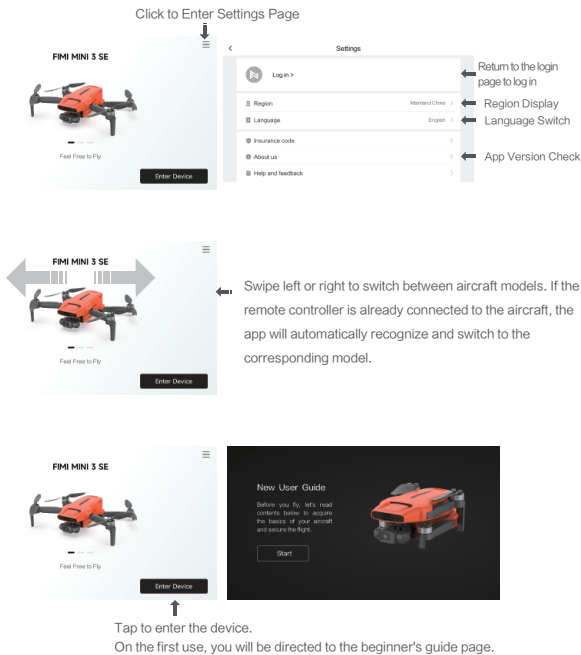

4. Gesture Operations

Enter the live view interface, swipe left to enter full-screen mode, and swipe right to exit full-screen mode.

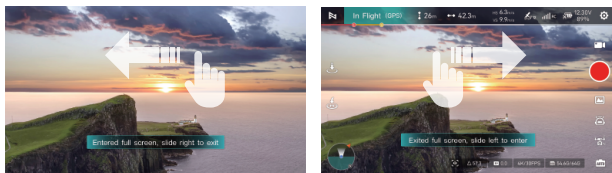

■ 5. Image Interface

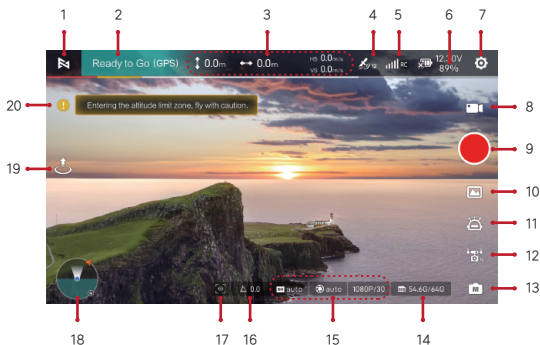







1. Return To Login Interface

 : Tap to return to the login interface.

2. The Current Flight Mode Of The Drone

 : Flight mode display: green bar: GNSS mode, yellow bar: VPU mode, red bar: ATTI mode. Click to enter the shortcut page of aircraft parameters



3. Real-time Parameter

-  : Height from the home point.
-  : Distance from the home point.
-  : Vertical speed of aircraft.
-  : Horizontal speed of aircraft.
-  : Battery level is only enough for landing.
-  : Remaining return power.

4. GNSS Signal Strength

 : Display the GNSS signal strength, low signal strength, marked in red; medium signal strength, marked in red; high signal strength, marked in white, click to enter the aircraft settings page. When the icon is white, it means the GNSS signal is good and you can refresh the return point.

5. Mapping Signal Quality

-  : Display RC signal. Tap to enter the RC setting.
-  : Display the 4G network and mobile device signal strength, click to pop up the 4G network status.

6. Battery Power

 : Display real-time battery level. Tap to enter battery setting.

7. System Settings

 : Including drone parameter settings, camera parameter settings, remote control parameters, gimbal settings, battery information, other parameter settings and so on.

Drone

Flight speed, distance, altitude, return altitude setting:

Enable/disable novice mode (limit speed, distance, altitude), the UAV will be limited to fly in a cylindrical space with 100m radius and 50m altitude, and will be limited to normal block. Set the UAV lost connection handling, return/landing/hovering.

FPV display HOME point, turn on/off precision landing, turn on/off indicator light, magnetic field environment interference amount, compass calibration, return point setting. Control feel setting, etc. Reset the drone parameters, the above settings are restored to the factory default settings.

Camera

Shortcut parameters, manual/automatic

General settings: video quality, video resolution, white balance, color, metering mode, video encoding format, grid lines, vertical shooting, segment recording and other settings. View SD card capacity and formatting.

Remote controller

Graphic transmission band, selectable 2.4G/5.8G band.

Remote control calibration, calibrate the center of handle, sense and maximum amount of scroll wheel Joystick mode, Japanese hand, American hand, Chinese hand.

Gimbal

Gimbal Calibration, Gimbal Tilt Speed, Advanced Calibration Settings.

Reset head parameters, restore factory default parameters.

Battery information

View information such as smart battery single cell voltage, current charge, cycle count, temperature, and overdischarge count.

Other

View flight logs, unit settings, sensor data, firmware version, find airplane and more.

8. Toggles The Current Mode Of The Camera

Photo modes:  single shot,  time-lapse

Video modes:  Normal Video,  Time-Lapse Recording

One-click clips:  skydiving,  self-timer flight,  fixed-point loop,  fixed-point spiral,  tail-flip flight

Panorama:  Landscape,  Vertical,  Wide Angle

9. Shooting Buttons

 : Tap to start recording video.

 : Tap to start shooting photos.

 : Tap to shoot one-tap video.

10. Media Library

 : Access to download and view videos and photos stored on the camera's Micro SD card on the drone.

11. Smart Flight

 : Click to enter the Smart Functions page. Intelligent Flight includes Pointing Flight, Route Flight, Follow 3.0, Point Wrap Flight, Spiral Flight.

Flight modes include Aerial Mode, Tripod, Heading Lock, Fixed Wing, SAR.

 : Waypoint flight.

 : Flight paths are flown.

 : Follow.

 : Point wrap flight.

 : Spiral flight.

 : Aerial mode.

 : Tripod mode.

 : Flight direction locked.

 : Fixed wing.

 : SAR mode.

12. Flight Gear Switching Shortcuts

 : Display the current flight gear, click to switch, smooth gear, normal gear, sport gear.

13. Camera Parameter Mode Shortcuts

 : Camera parameter mode, click for manual/automatic switching

14. SD Card Status Bar

 : The remaining capacity of SD card and total capacity of SD card are displayed, click to enter SD card setting.

15. Gimbal And Image Parameter

 : The current video resolution/frame rate is displayed in the video mode and the image size is displayed in the photo mode, and you can set the video or photo mode, resolution, image size, white balance, style and so on by clicking on it.

 : Displays the current Shutter value. In manual mode, click to set.

 : Displays the current ISO value, in manual mode, click to set.

 : The current EV value is displayed, click to set.

 : Fast zoom, support 4K/30/25/24 resolution 2.7K/60/50/30/25/24 resolution, 8M/12M photo taking.

16. Gimbal Pitch Angle

 : Display the current pitch angle of the gimbal, press and hold for 2 seconds to bring the gimbal down vertically, and double click the gimbal back to center.

17. Follow 3.0

 : After the GNSS mode takes off, click into Follow 3.0 mode.

18. Zoom Map / Attitude Sphere

 : Real-time display of the vehicle position, click to switch the mapping interface/attitude sphere/thumbnail map/full-screen map display.

Interface of map

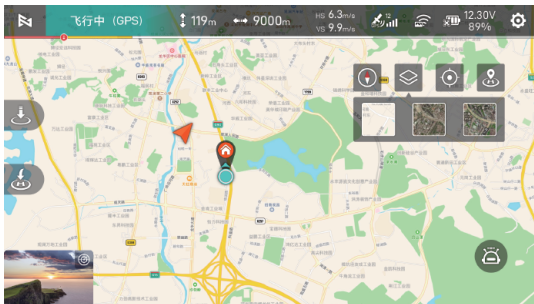

- : Tap to toggle to have the aircraft position centered or the aircraft and phone positions co-centered.
- : Display the location of the drone.
- : Display the location of the Home.
- : Display the location of the phone.
- : Tap to correct the direction.
- : Switch the map.
- : Home point.
- : Tap to switch to guided map.
- : Represent the direction of the phone.
- : The position of drone to the phone. And the direction of the drone.
- : Compass.
- : The position and percentage of the blue area on the circle represents the current attitude of the vehicle in the horizontal and pitch directions.

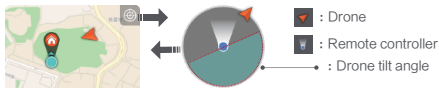

The Attitude Sphere displays information about the drone's nose orientation, tilt angle, remote control orientation, and return point location. The attitude ball is able to reflect the drone's angle and direction in real time, as shown in the following figure. The attitude ball can reflect the angle and direction of the drone in a realistic way, as shown in the figure below:

Attitude Ball Legend				
Drone tilt direction	Forward tilt: the water level line is biased toward the upper half of the stance sphere	Backward tilt: the water level line is biased toward the lower half of the stance sphere	Tilted to the right: the water level line is tilted to the right	Tilted to the left: the water level line is tilted to the left

19. Shortcuts



: Tap to auto takeoff.



: Tap to auto land the drone.



: Tap to return the drone.

20. Message Status Bar



STATUS BAR

: Alerts for restricted flight zones, environmental changes, temperature, sensor calibration, and more.



- Please ensure that your mobile device is fully charged before flying.
- When using the app, cellular mobile data is required. Please contact your mobile device's data provider for the latest data rates.
- When using the app, be sure to read and understand the prompts and warning messages that appear, and always be aware of the current status of the drone.
- If your mobile device is too old, it may affect the app's performance; consider upgrading your device.
- Height restrictions and no-fly zones vary by country and region, so please comply with local regulations.

Safety Protection

1. Auto-return

The drone is equipped with an automatic return function, the return trigger is mainly divided into user-initiated trigger, the drone low-battery trigger, lost connection trigger (remote control and the aircraft between the loss of communication signals).

Support lost return to home only in GPS mode. When the GPS signal is good, the compass works normally and the drone has successfully recorded the takeoff point, if the drone loses connection with the remote control signal for more than 2s, it will be judged that the drone has lost connection. The flight control system will take over the control of the drone and plan the return route with reference to the original flight path, and the drone will fly back to the take-off point. If the signal connection between the drone and the remote control returns to normal during the return process, short press the return button "📶" to take the lost connection and return, the vehicle will be returned to the control right.

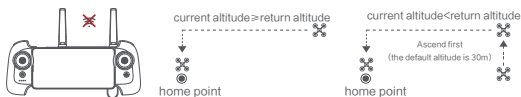

2. Low-power Protection

In flight, the App prompts the user to return when the battery power is only enough for the return flight. When the battery power is remaining 30% (default), the App prompts the low battery and suggests landing as soon as possible. When the battery power remaining 10%, the aircraft will start to land automatically. During landing, tap the return button "📶" to stop landing to cope with different environments.

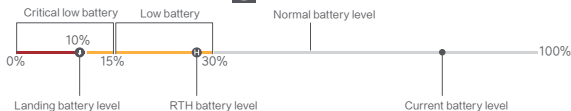

💡 · Low battery alarm range can be set in the App.

3. Hovering On The Edge of No-fly-zone

The drone will automatically hover in the restricted flight area designated by the state, such as the edge of airports, and the App will appear corresponding hints. The user can use sticks to fly the drone from the edge of the no-fly-zone, but the drone will not enter the no-fly-zone.



4. Height And Distance Limitations

Maximum altitude is used to limit the altitude of the vehicle and maximum distance is used to limit the distance of the vehicle, which can be set by the user in the FIMI Navi Mini App.

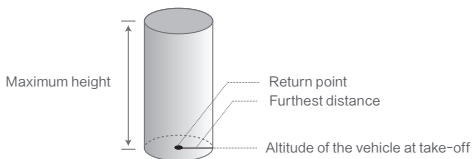

GNSS Good Signal

	Flight restriction	FIMI Navi Mini App
Maximum height	The flight altitude will not be able to exceed the maximum altitude set in the FIMI Navi Mini App	Indicates that the maximum altitude has been reached.
Furthest distance	The straight-line distance of the vehicle from the return point will not exceed the maximum distance set in the FIMI Navi Mini App.	Indicates that the maximum distance limit has been reached

5. Flight Environment Requirements

- The drone is dangerous and not suitable for use and operation by persons under 16 years of age and other persons who do not have full capacity for civil behavior.
- Please ensure that you keep a certain distance from people, animals, trees, vehicles and buildings during the use of the airplane. Please maneuver carefully when people are approaching.
- Please keep away from dangerous environments such as airports, railroads, highways, high-rise buildings and utility poles when operating the drone.
- Please stay away from areas with complex electromagnetic signals such as communication base stations and high-power antennas when operating the drone.
- The flight altitude and flight distance of the aircraft relative to the take-off point will be limited according to relevant regulations and policies.
- Do not use this product at locations and times where the use of such products is prohibited by regulations and policies.
- In order to protect the legitimate rights and interests of users, please ensure that the product safety instructions are observed during use.
- Please do not fly in bad weather such as windy, rainy, snowy and foggy.
- Please choose a location with good GPS signal and open environment to fly.
- It is recommended that the user is guided by an experienced user for the first flight.
- It is recommended to fly in the environment with good visibility, please pay attention to the safety of flight at night operation.
- This product is integrated folding design, does not support the installation of protective devices.
- This product does not support the use of overweight does not have the ability to load, more than the maximum takeoff weight of the drone may bring the uncontrollable flight, the resulting loss is borne by the user, and has nothing to do with FIMI.
- All flight data are saved in the user's mobile device, except for the user's initiative to upload to the cloud, the company will not get any of your flight data.

■ 6. Pre-flight Inspection

- Make sure that the battery power of the drone and the remote control are sufficiently charged.
- Make sure that the propeller is properly installed and that the propeller is not damaged or deteriorated.
- Make sure that the gimbal protector has been removed and the camera lens has been cleaned.
- Confirm that the SD card has been inserted.
- Propeller harnesses and gimbal protectors have been removed.
- Front and rear arms are fully deployed in place.
- The camera and gimbal are working properly when the power is turned on.
- FIMI Navi Mini App is connected and working properly.

■ 7. Novice Mode

Defaults to Novice Mode the first time you use the drone.

In Novice mode:

- Flying distance and altitude will be limited to: 0~100m.
- Steady mode is limited to photography gear.
- It is recommended for beginners to learn and skill the flyer in novice mode first.

Flight

1. Basic Flight

- Confirm the direction of the drone
- The gimbal camera position is the nose direction.
- Direction can also be determined by the color of the status light on the tail of the drone when the drone is turned on.

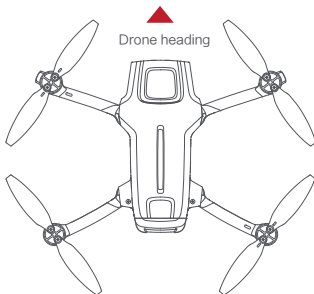

-  · Safety tip: Keep the tail facing the operator when maneuvering the craft to avoid misjudging the direction.

2. Take Off/Landing

- Keep both sticks to the bottom inner still over 3 seconds, the propellers start spinning.
- Release both sticks once propellers spinning, and firmly push the left stick upward to take off the drone.
- When the drone in flight, release the sticks and the drone will hover automatically.

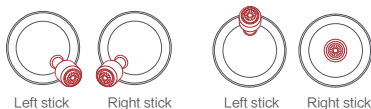

- Slowly move the left stick downward to land the drone.
- Once the drone landed, landed, push and hold the left stick down over 5 seconds, the motors will stop.



-  · When taking off, be sure to place the drone on a smooth and fixed plane, does not support hand-held and palm takeoff or landing.
- The drone is not waterproof, do not land on water, and for safety reasons, do not land on an inclined surface.

3. Basic Flight Operations

- Toggle the two rockers of the remote control inward and downward to the maximum extent, in the shape of an inner eight and hold it for more than 3 seconds, the paddles start to rotate.
- After the paddles start to rotate, release the two joysticks back to the center at the same time, and push the left joystick upward to take off the aircraft.
- During the flight, release the two joysticks of the remote control, the flying machine will hover automatically.

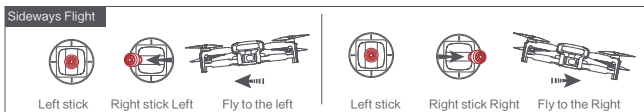
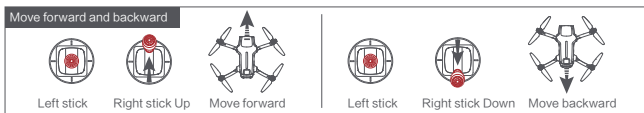
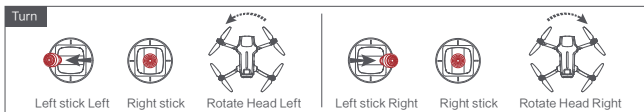
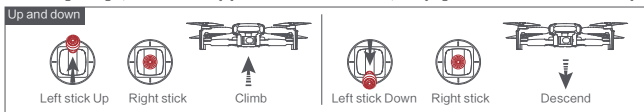

⚠ Remote control joystick settings can be changed in the remote control setup menu (default is US hand)

4. Stop Propellers In An Emergency

- When motors can't properly turn off, please toggle the left stick to the bottom inner in maximum range, and press Auto return-to-home button for 5 seconds simultaneously, the motors will stop.

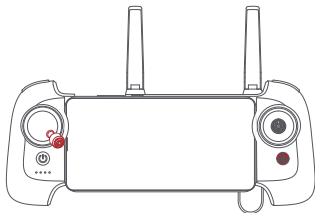

⚠ Do not do the operation above during normal flight to avoid motors being stopped in the air.

■ 5. Automatic Take-off/Landing/Return

· Automatic takeoff

When the drone meets the automatic takeoff conditions, click the automatic takeoff button on the left side of the APP "🚁" Follow the instructions, the drone will automatically take off, and when it reaches the specified altitude the APP prompts that the automatic takeoff is complete.

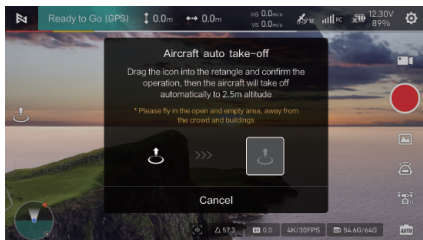

In GPS mode, the drone automatically takes off and hovers at 2.5 meters from the ground waiting for the joystick command; in VPU mode, the drone automatically takes off and hovers at 1.2 meters from the ground waiting for the joystick command.

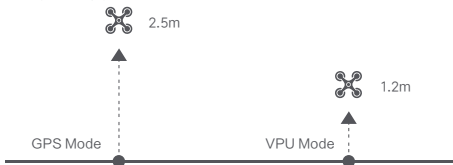

· Automatic landing

When the drone meets the conditions of automatic landing, click the automatic landing button on the left side of the APP "🚁" Follow the instructions to operate, the drone will be in the current flight position vertically descending to the ground, and when it reaches the ground the propeller stops rotating the APP prompts that the automatic landing is complete.

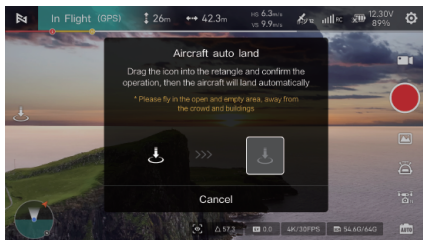

· Automatic return

When the drone is in the air, the user can long press the return button on the remote control with the remote control beep. Or through the auto return button on the left interface of the APP "🏠" to let the drone into the automatic return, after reaching the ground, the APP prompts that the automatic return has been completed.



When the drone is flying in the air, the user can long press the return button on the remote control to let the drone enter the automatic return. When the drone return distance $D < 10$ meters, if the flight altitude $H < 3$ meters, the drone rises to 3 meters and then return to the take-off point to land; if the flight altitude $H \geq 3$ meters, the drone directly maintains the current altitude to return to the take-off point to land. When the drone return distance $D \geq 10$ meters, if the flight altitude $H < 30$ meters, the drone first rises to 30 meters and then returns to the takeoff point to land; if the flight altitude $H \geq 30$ meters, the drone directly maintains the current altitude to return to the takeoff point to land. Users can cancel the automatic return flight through the remote control return button or through APP.

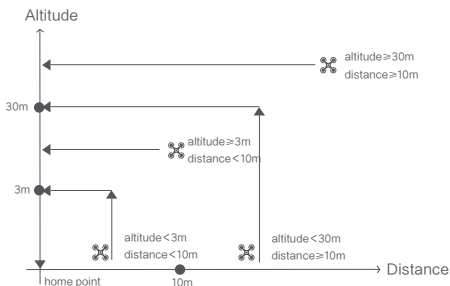

Intelligent Flight

1. Follow3.0

Follow-flight is supported only in GNSS mode.

Users can enter the Smart Flight menu from the "📷" icon in the Fimi Navi 3.0 APP, click "Follow Flight" to select Normal Follow, Parallel Follow or Locked Follow, and the drone will follow the target selected in the APP as the tracking target.



· Ordinary following

In normal following mode, the nose of the drone is always aimed at the tracking target, and flies at a certain distance with the tracking target moving direction as the course.



· Parallel following

In parallel following mode, the nose of the vehicle is always aligned with the tracking target and flies at a certain distance with the fuselage left and right directions as the course.

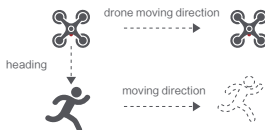

· Lock following

In lock mode, if the flight speed is 0, the vehicle will hover 360° at the follow target position. The user can also adjust the flight speed and the drone will fly around the target at a certain distance.



- ⚠ During the following flight, the user should make sure that the following path always avoids people, animals and obstacles, etc. to ensure the flight safety.
- Users must comply with local laws and regulations when using the follow-flight function.

2. Orbit A Point Flight

The user selects orbit a point flight on app, set the center point and radius. The drone will fly around the center point at a default speed. If the user sets a POI, the drone will lock and shoot the POI. Fly away from the central point to set radius. Set flight speed, move direction and heading. If the heading is free, the user can drag a rectangle around a POI.

- Fly to a point first to set the center point.
- Then set the flight radius by starting with the center point.
- Set the flight speed, movement direction and heading.
- After setting the parameters, click "GO" to execute.



During the orbit a point flight, you can set the steering and speed of the go-around flight on the Fimi Navi 3.0 APP, and click "X" to exit the orbit a point flight.

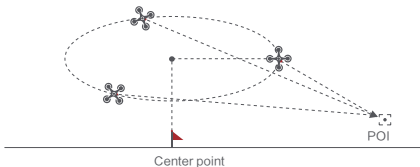

If sticks are moved in flight, the flight altitude or radius will be changed.
Taking Mode 2 as an example:

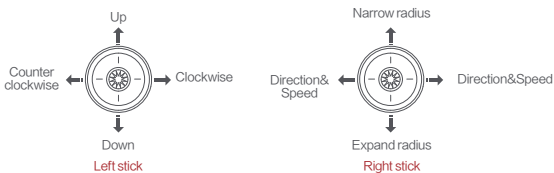

3. Spiral Flight

Users can select the spiral mode in the app, set the center point and radius, and the craft will hover up and shoot video at the same time, showing a strong sense of space.

- Fly to a point set to the center point.
- Fly away from the center point set to radius.
- Set the circling direction and flight distance while starting the video recording.
- Operate the joystick during flight and the craft will interrupt the spiral airplane.

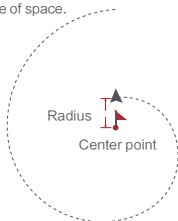

4. Tap-fly

The user can select Tap-fly in the App. Tap map to choose a destination and set flight speed, the drone will fly over there at a default speed in a straight line. If a point of interest is set, the camera will be locked at the POI.

- Tap the map to choose a destination.
- Switch to image interface to drag a rectangle around the POI.
- Set flight altitude and speed.

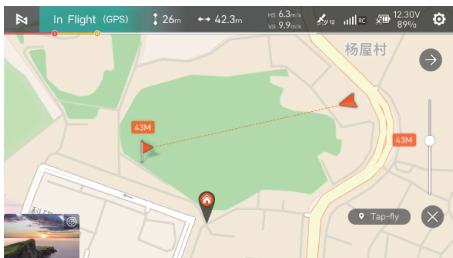

■ 5. Waypoint

Choosing waypoint and drawing route both are available at map. The drone flies along waypoint route at a default speed. If a point of interest is set, the camera will be locked at the POI. The user can select a way to set waypoints, including choosing points in flight or on the map, historical routes.

Choosing points in flight:

- Control the drone to a point to set as a waypoint.
- Using sticks to set flight altitude and heading direction, dials to set gimbal angle, and actions when reaching the waypoint.
- When all waypoints ready, please set waypoints routes attribute, including flight speed, heading direction, action at the destination.
- POI is enabled when executing waypoints.

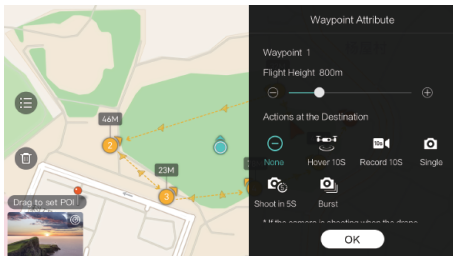

■ 6. Precise Landing

In the process of Return to Home, the optical flow sensor will match landing pad features above the home point. Once matched successfully, the drone will land on the landing pad precisely.

Click on Settings "⚙️" -> Click on drone "🚁" -> Select Precise Landing

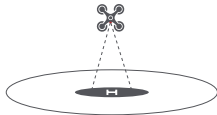

⚠️ · Please turn on this feature in the app in advance.

■ 7. Intelligent Flight Mode

The following modes need to be used when flying in GNSS mode, short press the remote control return button "🏠" or click the App "❌" to exit the mode.



Aerial Mode

When the drone is flying in GNSS mode again, you can enter the aerial photography mode in the app's mapping interface -> click 📷 -> select 📷 -> enter the aerial photography mode. In aerial mode, the braking distance of the drone is increased, the rotational angular speed is limited, the control is softer, and the shooting images are more stable and smooth.



Tripod Mode

When the drone is flying in GNSS mode again, you can enter SAR mode in the app's mapping interface -> click 📷 -> select 📷 -> enter SAR mode. The maximum flight speed of the aircraft is 1m/s, and the maximum rotation speed is 60 degrees/s. The sensitivity of the drone is reduced in tripod mode, and the shooting images are more stable and smooth.

Course Lock

When the drone is flying in GNSS mode, you can enter SAR mode by click  -> select  -> enter SAR mode in the App Mapping interface, the drone will take the current nose direction as the forward direction, and the direction is locked. You can change the nose direction and adjust the shooting angle by rocking the joystick, but the forward direction is unchanged.

Fix-wing Mode

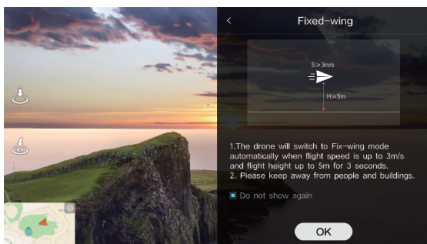

When the drone is flying in GNSS mode again, you can enter the fixed wing mode in the App mapping interface -> click  -> select  -> enter the fixed wing mode, at this time, the drone can only fly forward, can not go backward.



The user can freely control the speed and forward direction of the vehicle through the joystick. As shown below:

Left stick	push upward	up
	Push downward	down
	toggle left	turn left
	toggle right	turn right
Right stick	push upward	accelerate
	push downward	decelerate
	toggle left	turn left
	toggle right	turn right

SAR Mode

When the drone is flying in GNSS mode again, you can enter SAR mode in the App mapping interface -> click  -> select  -> enter SAR mode, at this time, the mapping interface will display the GNSS coordinates in real time, and the vehicle can help to search and rescue.

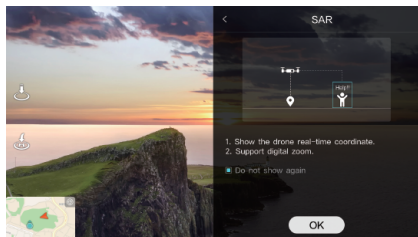

The interface of map transmission shows the coordinates of the aircraft and the current time in real time, and supports the functions of map transmission screen indentation and screenshot.



The map interface displays the coordinates of the drone and the current time in real time, and supports the function of switching satellite maps and taking screenshots.

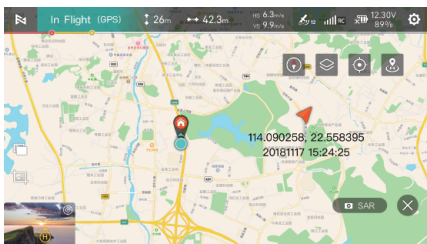

One-Tap Short Film

The one-tap short film includes five sub-modes: Sky, Selfie, Surround, Spiral, and Tail. The drone can automatically fly according to the selected shooting mode and continue to shoot for a specific length of time, and then automatically generate a short video at the end. When you need to fly in GNSS mode again, short press the remote control return button "🏠" or click the App "✕" to exit the mode.

1. One-click Video Mode

- Surfing flight, select the target, the airplane will rise quickly according to the set height and shoot a video.
- Selfie Flight, select the target, the airplane will fly high and far according to the set distance and current gimbal angle, and shoot a video.
- Fixed Circle, select the target, the airplane will keep the current altitude and the horizontal distance from the target as the radius, circle around the target and shoot a video.
- Fixed Point Spiral, select the target, the aircraft will take the center point directly above the target as the center point, the horizontal distance from the target as the inner circle radius, according to the set radius difference spiral around the center point at a uniform speed for a circle, and shoot a video.
- After selecting the target, the aircraft will take the target as the center, fly around the center at a constant speed according to the set way and route, and shoot a time-lapse video.

2. Launching One-Tap Short Film

- Start the drone and take it up to more than 5 meters above the ground.

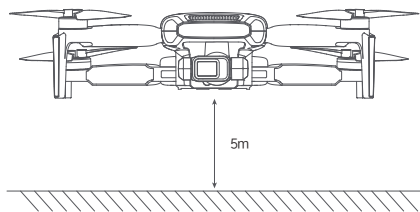

- Tap the Shooting Mode icon, select One-Tap Short Film and read the Beginner's Guide and Notes. Make sure you fully understand and can safely use this function.

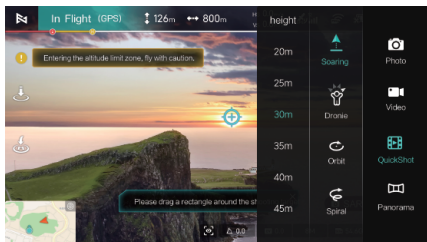

- After selecting the sub-mode, select the target on the screen. Tap Start, the drone will automatically fly and shoot video, and return to the starting point when shooting is complete.



- ⚠ Use the One-Tap Short Film function in an open and unobstructed environment and always be aware of obstacles in the path of the vehicle such as people, animals, buildings, etc. -Always be aware of objects from around the drone and use manual operation to avoid accidents (e.g. collisions) and obstructions.
- Always be aware of objects from all around the vehicle and avoid accidents (e.g., collisions) and obstructions to the vehicle through manual operation.
- The vision system does not work properly in the following scenarios and it is not recommended to use One-Tap Short Film:
 - a. When the filmed object is obscured for a long period of time or is located out of the line of sight.
 - b. When the subject is more than 50 m away from the vehicle.
 - c. When the subject is very similar in color or pattern to the surrounding environment.
 - d. When the subject is in the air; e. When the subject is moving at a high speed.
 - f. When the environment is particularly dark (less than 300 lux) or particularly bright (more than 10,000 lux).
- Please don't use the One-Tap Short Film in the location with poor GNSS signal, such as near buildings or covered areas, or it may lead to unstable flight trajectory of the aircraft and other accidents.
- When using the One-Tap Short Film feature, users must comply with local laws and regulations regarding privacy rights.

Calibration

1. Compass Calibration

Pay attention to the observation according to the App prompts. Changing the flight site, the drone detects the surrounding environment requires compass calibration. Calibration steps:

- When calibration is needed, the App will pop up the calibration prompt, after calibration, the indicator light of the drone will be green and you can calibrate it.
- Rotate the drone horizontally for more than 2 turns, the interface will change to vertical calibration after successful calibration, and the indicator light of the drone will be red during the calibration process.
- Rotate the drone horizontally with the nose facing upward for more than 2 revolutions until the calibration interface indicates that the calibration is complete. The indicator light is always on green.
- Users can also trigger the compass calibration manually in App System Settings->Aircraft->Compass Calibration.

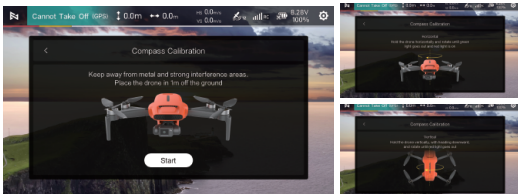

⚠ · If calibration fails multiple times, update the calibration site.

⊘ · Do not calibrate the compass with the arms retracted.

2. Gimbal Calibration

After the drone is powered on and the self-test is completed, if you find that the gimbal can not be activated or there is obvious tilt after the gimbal is activated, you need to calibrate the gimbal before taking off.

- Calibration Procedure

Gimbal trim corrects the gimbal offset by adjusting the angle of the gimbal's roll and yaw offset individually, while the calibration screen displays the vehicle's picture transmission. When the aircraft is placed on a horizontal plane and the gimbal cannot be kept horizontal with a slight tilt, it can be corrected by fine tuning.

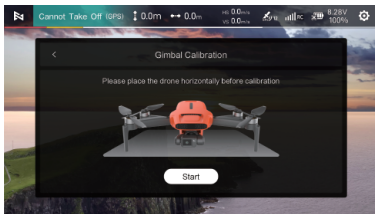

⚠ · Please connect the airplane and gimbal before calibration, gimbal calibration can not be done in flight.

- Please choose a flat and stable environment during calibration, otherwise calibration will fail.

· Gimbal Fine-tuning

Gimbal trim corrects the gimbal offset by adjusting the angle of the gimbal's roll and yaw offset individually, while the calibration screen displays the vehicle's picture transmission. When the aircraft is placed on a horizontal plane and the gimbal cannot be kept horizontal with a slight tilt, it can be corrected by fine adjustment.

· Gimbal Fine-tuning Features

- Enter the gimbal fine-tuning interface to adjust the gimbal horizontal and yaw angle, its adjustment range is $\pm 10^\circ$. Every time you click "+/-", the angle of the gimbal will be "+0.1°/-0.1°", or you can directly input the angle value through the keyboard to adjust.
- Horizontal Adjustment: Click + to roll to the right, click - to roll to the left. Yaw Adjustment: Click + to yaw to the right, click - to yaw to the left.
- Click "Default" to return the gimbal to its default angle (0°).

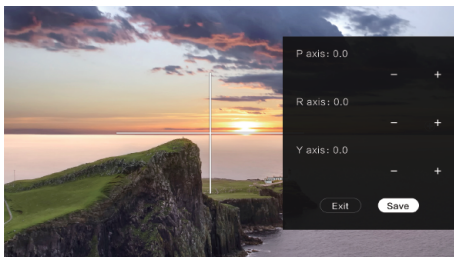

■ 3. Remote Control Calibration

When you find that the remote control operation and the drone flight response are not consistent during the flight, you can try to calibrate the remote control. Select Remote Control Calibration in APP Remote Control Settings, and click Start to enter Neutral Calibration.

- Do not touch the stick during calibration.
- After successful center calibration, skip to rocker calibration. Follow the prompts to dial the stick to maximum travel.
- After successful stick calibration, skip to roller calibration. Follow the prompts to dial the sticks to maximum travel.



⚠ · When calibrating the remote control, please turn off the power of the drone; during flight, it is impossible to calibrate the remote control.

Maintenance

■ Propellers Maintenance

Propellers are wearing parts. When they're damaged, replace them in time to ensure flight safety and efficiency.

■ Battery Maintenance

Do not throw the battery into fire; Do not batter the battery; Lithium battery's capacity reduces significantly in low temperature conditions. Do not use the battery when it is below 0 degrees. Do not place the battery under the burning sun.

■ Gimbal Calibration

The gimbal of FIMI MINI 3 is an integrated gimbal and cannot be disassembled. Please be careful not to scratch the camera when storing it in the aircraft, and pay attention to the cleanliness of the camera. The gimbal is a precision component, please do not squeeze it.



■ Drone Self-check

The drone enters the self-check when the drone is powered on. If the self-check failed, App will pop up corresponding hints.

■ Firmware Upgrade

Please check the firmware version regularly, new version will be updated by Fimi Navi App to prompt users to update. Please download new firmware when the App is connected with the drone and remote controller.

Product firmware version query path:

Enter the image transmission interface, click System Settings  "-> Pull down and select Others  "-> Click Firmware Upgrade to view the current version

Basic Specifications

Drone

Model: FMWRJ04A3

Dimensions (folded, without propellers):

Length 145mm × Width 85mm × Height 56mm

Dimensions (unfolded, without propellers):

Length 200mm × Width 145mm × Height 56mm

Takeoff Weight: Approx. 245g

Diagonal Distance: 214mm

Max Ascent Speed: 4m/s

Max Descent Speed: 2m/s

Max Flight Speed: 16m/s *in a windless environment at sea level

Max Takeoff Altitude: ≤4000m

Max Hovering Time: 29 minutes *Measured with the aircraft hovering in windless conditions, with visual and recording modes turned off, at sea level until the remaining battery level reaches 0%. This is for reference only; please pay attention to app prompts during actual flight.

Maximum Flight Time: 32 minutes *Measured with the aircraft flying forward at a speed of 21.6km/h in windless conditions at sea level until the remaining battery level reaches 0%. This is for reference only; please pay attention to app prompts during actual flight.

Max Tilt Angle: 35°

Max Wind Speed Resistance: 10.7m/s

Operating Temperature Range: 0-40°C

Satellite Navigation Systems: Beidou/GPS/GLONASS/Galileo

Hovering Accuracy, Vertical: ±0.1m (when Vision Positioning is active)

±0.5m (when GPS is active)

Horizontal: ±0.3m (when Vision Positioning is active)

±0.5m (when GPS is active)

Remote Controller

Model: FMYK04A3

Product Weight: Approx. 260g

Dimensions: 165mm × 89mm × 47mm

Operating Frequency:

2.4000 GHz - 2.4835 GHz

5.725 GHz - 5.850 GHz

Max Battery Life: 8 hours *Without charging the mobile device

4 hours *Charging the mobile device

*Measured with mobile device battery level above 95%; actual results may vary depending on different mobile devices and their battery levels at the time of testing. Please refer to actual usage.

Battery Type: Li-ion

Battery Capacity: 3500mAh

Nominal Voltage: 3.7V

Input: 5V = 2A

Operating Temperature Range: 0-40°C

Charging Temperature Range: 5-40°C

Max Signal Effective Range

(No interference, No obstruction) FCC: Approximately 9 km *The above data is measured in an outdoor open environment interference and is the farthest communication distance for one-way non-return flights under various standards. Please pay attention to the app's return prompts during actual flights.

Minimum Latency: Approx. 120 milliseconds

Supported Mobile Device Interface Types: Lightning, USB-C

Gimbal

Mechanical Gimbal: $-110^{\circ} \sim 40^{\circ}$ (Pitch)
 $-40^{\circ} \sim 40^{\circ}$ (Roll)
Controllable Rotation Range: $10^{\circ} \sim -90^{\circ}$ (Pitch)
Angular Vibration Range: $\pm 0.01^{\circ}$

Camera

Image Sensor: 1/2.5-inch CMOS
Lens: FOV 94°
Aperture: f2.2
Format Length: 2.35mm
Format Equivalent: 20mm
Focus: 0.8 to ∞
Effective Pixels: 12 million pixels
ISO Range: Video 100-6400
Photo 100-6400
Shutter Speed: 1/8000s-2s
Max Photo Size: 4000 \times 3000
Max Video Resolution: 3840 \times 2160@60/30/25/24fps
Max Bitrate: 100Mbps
Video Format: MP4
File System: FAT32/exFAT
Photo Format:JPG
Digital Zoom: 6x

Intelligent Flight Battery

Capacity: 2200mAh
Weight: Approx. 85g
Nominal Voltage: 7.7V
Charging Limited Voltage: 8.8V
Battery Type: Li-ion 2S
Energy: 16.92Wh
Charging Temperature: 5-40°C

APP System Requirements

FIMI Navi Mini Mobile Device System Requirements:
iOS 12.0 or later / Android 9.0 or later

Official website: www.fimi.com
Customer service email: support@fimi.com
Service hotline: 400-661-0908
Manufacturer : Shenzhen FIMI Robot Technology Co.,Ltd
Address: No.1213-1217,12F,West Block,Tianliao Building, 1133 Xueyuan Avenue,
Taoyuan Street, Nanshan District, Shenzhen City,Guangdong Province, China